

# World JOTA Report

an account of the world-wide

42nd

Jamboree On The Air

16 - 17 October 1999



Each year in the third full weekend of October hundred-thousands of Scouts and Guides all over the world exchange greetings, learn about each others country and culture, swap programme ideas and make new friends. The contacts between them are established by amateur radio stations. This Jamboree-On-The-Air (JOTA) is the largest annual event for Scouts.

Chaque année durant le troisième week-end d'octobre, des centaines de milliers de Scouts et Guides dans le monde entier échangent des salutations, apprennent la culture des autres pays, se transmettent des idées de programme et se font des nouveaux amis, tout cela par contacts entre stations de radioamateurs. Ce Jamboree-Sur-Les-Ondes (JSLO) est la plus grande manifestation annuelle du Scoutisme. (Résumé français au chapitre 2).

Resumen español en el capítulo 2.

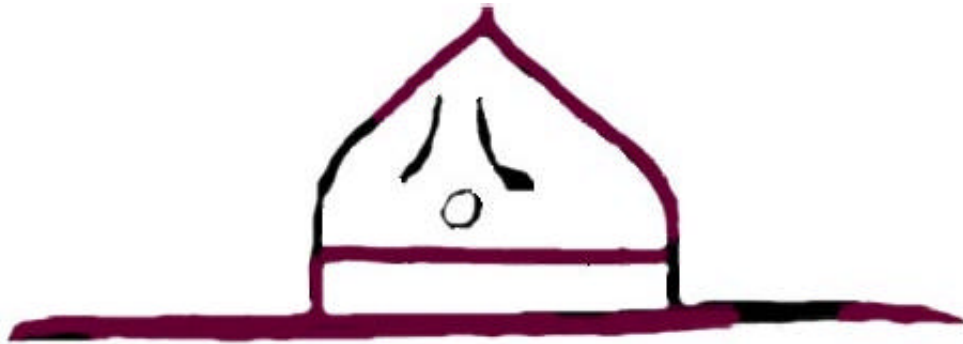

## Contents:

1.	From your editor....	1
2.	Résumé français /resumen español	2
3.	The 42nd JOTA and JOTI in figures and graphs	3
4.	The millennium adventure of John Bont	8
5.	JOTA goes digital....	9
6.	JOTA in print....	10
7.	Reports from countries	15
8.	Kit Corner	37
9.	Forthcoming events	39
10.	The 43rd JOTA	40
11.	JOTA Organizers	41

©2000.

World Organization of the Scout Movement, Geneva, Switzerland. All rights reserved. Member Scout Organizations may reproduce portions of the text for non-commercial use, with credits for its source.

Published by the World Scout Bureau. Publication number 1310.

# 1. From your editor....

Before you lays the account of the 42nd Jamboree On The Air. The JOTA, which is the largest annual WOSM event that enjoys a participation of some half-a-million scouts each year.

The JOTA starts on the Saturday at 00:00 hours local time and runs for 48 hours. Due to the world's time differences, we actually have a longer period over which scout stations can be heard on the air. The graphs below illustrates this. Combining this information with a prediction chart for radio propagation, will tell you at what times during the weekend you have the best chances to contact scouts in a certain part of the world.

Like last year, the JOTA enjoyed the presence of a second WOSM event on the same weekend: the Jamboree On

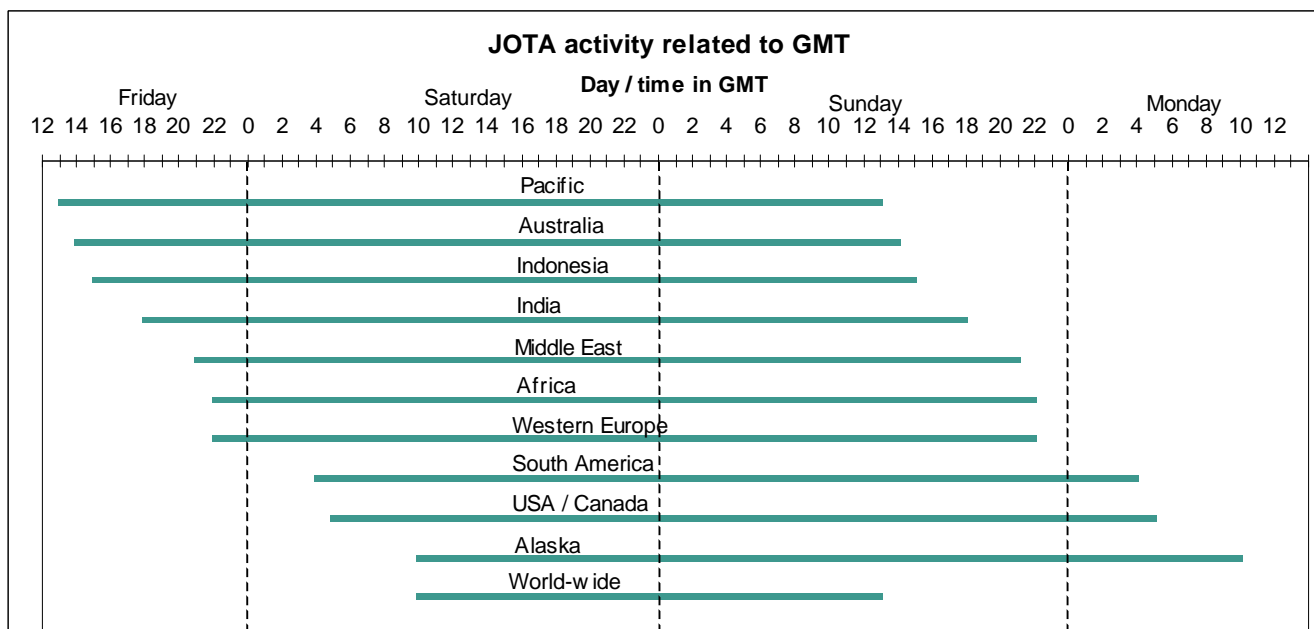

The Internet, or JOTI for short. From the reports it is apparent that most scout groups used internet in combination with amateur radio stations. This has of course the main advantage that one can use the combination of the two events to its fullest to enhance the weekend programme for the scouts. In most cases the national organisation teams take care of both events and we see more and more information material appear that combines these two popular ways of communicating with brother scouts world-wide. The use of internet is certainly acquiring its own place within this communication weekend. Where adequate, you will see some internet-related information appear in this JOTA report.

One such combined activity was the John Bont game. Scouts needed a radio station as well as internet access to solve this puzzle game. From the reports I noted that it was quite popular, despite that not that many scouts were able to find the correct solution. In case you're still wondering, have a look in chapter 4.

The design competition for electronic kitbuilding was not a popular thing as we received just 1 official entry (UK). It did not fulfill all the requirements so the jury decided to give it a special mention but not to award any prizes this time. Maybe the competition did not get a lot of national publicity or designing these kits is just a difficult job. Quite a number of countries, however, mentioned the kit building activities for their scouts, so I conclude that the actual kit-building activity as such is popular among scouts.

I would like to welcome the following new National JOTA Organisers (NJO) who joined or rejoined us this year: Brian Lodahl (Denmark), Joseph Russel (Dominica), Markus Hamro (Finland), Lars Weimar (Germany), Ranarisaona Raymond (Madagascar), Adil Freidji (Morocco), Silvio Monteiro (Mozambique), Eric Macias (Panama), Mamadou Daffe (Senegal), K. Fernando (Sri Lanka), Saisthara Pichaichannarong (Thailand). I hope you all enjoy the job of creating the JOTA event for the scouts in your country as much as we all do.

And now,... on to the next pages to enjoy the stories of the 42nd JOTA!

Richard Middelkoop, PA3BAR  
 Editor  
 Sunday 6 February 2000

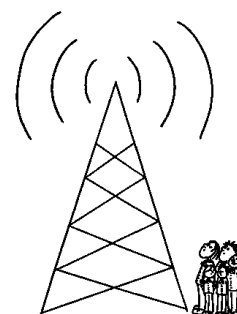

# 2. Résumé français / resumen español

Je suis heureux de pouvoir vous présenter le compte rendu du 42e Jamboree-sur-les-Ondes. Le JOTA est la plus grande manifestation annuelle de l'OMMS à laquelle participent plus d'un demi-million de scouts chaque année.

Le JOTA débute le samedi à 00h00, heure locale, et se termine 48 heures plus tard. Le décalage horaire permet cependant aux stations scouts de rester plus longtemps sur les ondes comme le montre les graphiques sur la première page. En combinant ces informations et les prédictions de propagation radio, vous saurez quelles sont les heures auxquelles vous aurez le plus de chance de contacter des scouts et dans quelle partie du monde.

A l'instar de l'an passé, une deuxième manifestation de l'OMMS, le Jamboree-sur-Internet (JOTI), s'est déroulée parallèlement au JOTA, le même week-end. Les rapports reçus indiquent: que de nombreux groupes ont combiné Internet avec le Radio, ce qui a permis de varier encore davantage les activités du week-end; que les équipes nationales s'occupent pour la plupart de l'organisation simultanée des deux événements; que ces deux moyens de communication sont populaires parmi les scouts du monde entier. Internet prend place dans cet événement voué à la communication.

Vous trouverez dans ce rapport quelques informations concernant Internet. Cette combinaison d'activités a permis d'organiser le jeu de Jean Bont. L'utilisation de la station radioamateur et d'Internet était nécessaire pour trouver la solution. Le jeu a remporté un franc succès, même si peu de scouts ont trouvé la solution. Si vous la cherchez encore, reportez-vous au chapitre 4.

Par contre, le concours de dessins de circuits électroniques n'a pas eu le succès escompté: nous avons reçu le dessin d'un seul et unique concurrent officiel, provenant du Royaume-Uni. Leur projet n'ayant cependant pas rempli toutes les conditions, le jury a décidé de lui donner une mention spéciale, mais de ne pas attribuer de prix cette fois. On ne sait pas s'il s'agit d'un manque de diffusion au niveau national ou si le projet était trop compliqué à réaliser. Le fait est que plusieurs pays ont indiqué avoir inclus la fabrication de circuits électroniques. J'en conclus que cette activité reste d'actualité.

D'autre part, j'aimerais souhaiter la bienvenue aux nouveaux organisateurs nationaux du JOTA, qui se sont joints - ou ont rejoint - notre équipe en 1999. J'espère que chacun d'entre eux se plaît à organiser le JOTA pour le bénéfice de tous les scouts, autant que je l'apprécie moi-même. Et maintenant... tournez la page pour découvrir ce qu'a été le 42e JOTA 1999.

Este es el recuento del 42do Jamboree-en-el-aire. El JOTA, que es el evento anual más grande de la OMMS, atrae una participación de más de medio millón de scouts cada año.

El JOTA comienza el día sábado a las 00:00 hora local y dura 48 horas. Debido a las diferencias de horario a través del mundo, en realidad el periodo durante el cual se pueden escuchar estaciones scouts en el aire es más largo, como se puede apreciar en los gráficos en la página una. Al combinar esta información con una tabla de predicciones para propagación de radio, se puede determinar en que momento durante el fin de semana tienes las mejores posibilidades de contactar a scouts en un determinado lugar del mundo.

Igual que el año pasado, el JOTA disfrutó de la realización de un segundo evento de la OMMS durante el mismo fin de semana: el Jamboree en el Internet, o JOTI. Según los informes recibidos, parece que la mayoría de los grupos scouts usaron Internet en combinación con estaciones de radio aficionado. Esta modalidad tiene la gran ventaja de permitirnos aprovechar la combinación de los dos eventos al máximo para realizar el programa del fin de semana para los scouts. En la mayoría de los casos, los equipos de las organizaciones nacionales se encargan de ambos eventos.

Así también aparece cada vez más material informativo que combina estos dos métodos populares de comunicarse con hermanos scouts a través del mundo. Sin duda, el uso del Internet está forjando su propio espacio en el fin de semana de la comunicación. Cuando sea apropiado, ustedes verán aparecer en este informe JOTA información relacionada con Internet.

Un ejemplo de una actividad combinada fue el juego John Bont. Los scouts necesitaban una estación de radio y acceso a Internet para solucionar este juego-acertijo. Los comentarios indicaron que fue bastante popular, a pesar de que no muchos scouts pudieron encontrar la solución correcta. Por si todavía la están buscando, den una mirada al capítulo 4.

La competencia de diseño de juegos de herramientas electrónicas no fue popular, ya que sólo recibimos una postulación oficial (Reino Unido). Además, esta postulación no cumplió con todos los requisitos, por lo que el jurado decidió otorgarle una mención especial y no dar

premios en esta ocasión. Tal vez la competencia no recibió mucha publicidad nacional, o diseñar este tipo de juegos de herramientas es una tarea demasiado difícil. Sin embargo, varios países mencionaron las actividades de construcción de juegos de herramientas para sus Scouts, lo que indica que la actividad en sí es popular entre los Scouts.

Quisiera dar la bienvenida a los siguientes nuevos Organizadores Nacionales de JOTA (NJO), que se integraron o se reintegraron este año. Espero que todos hayan disfrutado la tarea de realizar el JOTA para los scouts de su país tanto como nosotros.

Y ahora... seguimos a las próximas páginas para disfrutar las anécdotas del 42do JOTA.

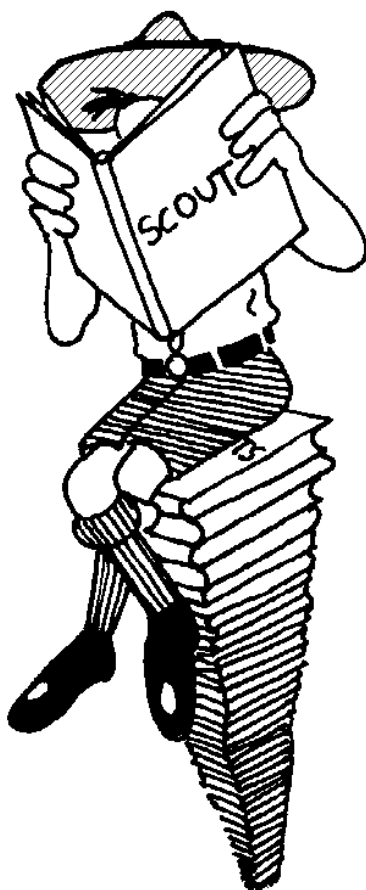

# 3. The 42nd JOTA and JOTI in figures and graphs

The 42nd Jamboree-On-The-Air enjoyed an enthusiastic world-wide participation. The World Scout Bureau is pleased to announce that we received a record number of JOTA reports from many countries. Our thanks go especially to those National JOTA Organizers and International Commissioners who have sent us the information of the JOTA in their country.

In this chapter, we have included statistics of JOTI participation as well. Merely to give you an idea of the interest in the growing use of internet technology during the weekend. Both participation statistics have been calculated in the same way.

Scout amateur radio stations operated from the following countries for the 42nd JOTA:

I	R		I	R		I	R		I	R					
*	13	9	<u>Algeria</u>	*	4	16	France	*	15	Madagascar	*	0	31	<u>Senegal</u>	
	4	17	Argentina	*	2	35	<u>Germany</u>	*	3	5	Malaysia			2	Singapore
	7	13	Australia			2	Ghana		2	19	Malta	*	6	26	<u>Slovakia</u>
*	1	31	Austria		3	15	Greece		1		Mauritius	*	5	23	<u>Slovenia</u>
		1	Bangladesh			2	Grenada		10	7	Mexico	*	8	6	<u>South Africa</u>
		2	Barbados		2	1	Guatemala	*	20	5	Morocco	*		30	Spain
*	4	16	Belgium			3	Guyana	*	38	--	Mozambique	*		1	<u>Sri Lanka</u>
*	1	14	Bolivia	*		6	<u>Honduras</u>		1	2	Namibia			1	St. Lucia
		4	Bosnia	*	2	3	Hong Kong		1	1	Nepal		1	1	St. Vincent
*	5	12	Brazil	*	3	23	<u>Hungary</u>	*	5	19	<u>Neth. Antilles</u>			2	Sudan
		7	Bulgaria		1	4	Iceland	*	3	52	<u>Netherlands</u>			1	Surinam
*	39	28	<u>Canada</u>	*	15	16	<u>India</u>	*	1	9	<u>New Zealand</u>		1	2	Swaziland
*	9	13	<u>Chile</u>		2	6	Indonesia		1		Nicaragua		7	21	Sweden
*		11	<u>China Rep.</u>	*	1	9	Ireland		1		Nigeria	*		19	Switzerland
	5	5	Colombia		2	5	Israel	*	1	34	<u>Norway</u>	*	1	10	<u>Thailand</u>
	2	4	Costa Rica		6	21	Italy	*	1	44	<u>Oman</u>			2	Trinidad & Tobago
*	41	25	<u>Croatia</u>			1	Jamaica		1	1	Pakistan		1	5	Tunisia
*	15	14	<u>Cyprus</u>	*	2	12	Japan	*	19	7	<u>Panama</u>	*	4	13	Turkey
*		47	<u>Czech Rep.</u>			2	Jordan		1	6	Paraguay			12	<Ukraine>
*	2	11	<u>Denmark</u>		1	2	Kenya		3	1	Peru	*		50	United Kingdom
*	10	12	<u>Dominica</u>		1	7	Korea		2	5	Philippines	*	12	22	United States
	1	2	Dominican Rep.	*	1	9	Kuwait			34	<u>Poland</u>	*	14	6	<u>Uruguay</u>
		1	Ecuador			3	Latvia	*	17	51	<u>Portugal</u>		3	8	Venezuela
	2	2	Egypt			3	Lebanon		1	7	Puerto Rico	*	20	67	World Bureau
	3	1	El Salvador			1	Lithuania	*	21	29	<u>Romania</u>		4	9	Yugoslavia
		3	Estonia		2	14	Luxembourg		14		<Russia>		2		Zambia
*	1	27	<u>Finland</u>		1		Macedonia		1		San Marino		1	2	Zimbabwe

Figure 1. Countries from which scout stations operated during the 42nd JOTA.  
The number of other countries that were contacted is shown in front of a country's name, where "I" indicates contacts via internet and "R" contacts via radio.  
\* indicates that a National JOTA Report is received and is quoted in chapter 7.  
underlined indicates that non-licensed scouts are allowed to speak themselves.  
<country> indicates that the (re-)emerging Scout Organization is not (yet) a recognized WOSM member.

Figures, numbers and statistics. Do they really matter? To some they don't, to others they do. The main thing is, of course, to have an enjoyable weekend. If you are a National Organizer, however, you may want to explain to your sponsors what the impact of the JOTA is. Your supporters at your national headquarters may want to know for how many scouts they pay all these organisation costs e.g. Is this all worth while? "Yes", you may tell them, "the JOTA is the largest WOSM activity around". And it is held annually. To back up your statement and to convince your supporters, the next three pages have all the numbers you may need. Figure 2 shows the number of participating scouts and guides as a percentage of the total membership of scouts and guides (WOSM) and guides (WAGGS) per country. For simplicity, beavers, cub-scouts, scouts, rovers and explorers have all been regarded as "scouts" and similarly for the girls.

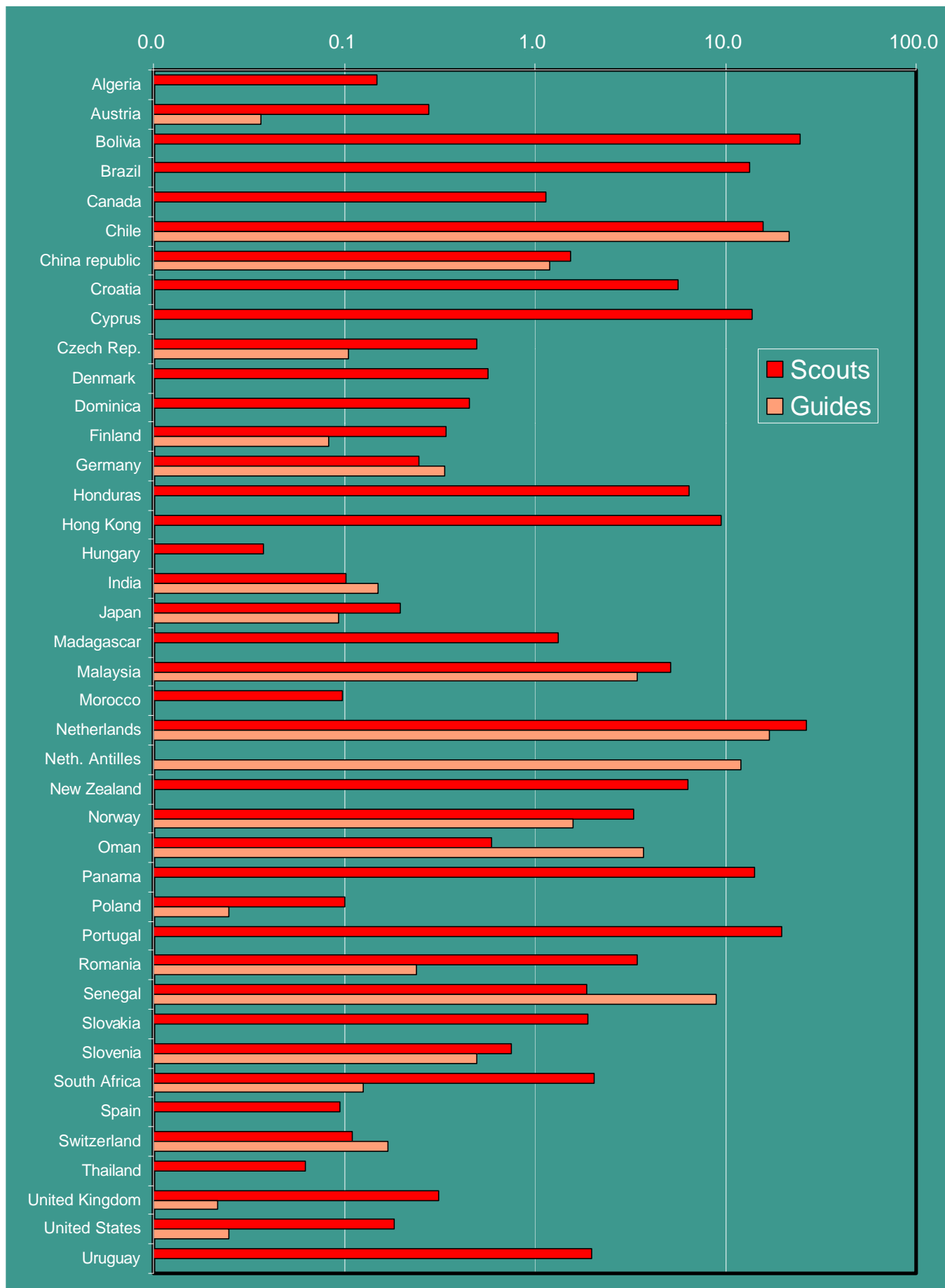

Figure 2. Percentage (%) of scouts and guides per country taking part in the JOTA.  
(Note: logarimic scale !)

Using a relative number makes it easier to compare the participation in different countries. Please note that we have used a logarithmic scale in this graph. That means that both small and large numbers can be displayed in the same picture, but that the axis is not linear.

JOTA is not a competition and these figures merely indicate that there are differences in interest, organization and reporting in these countries. Local circumstances vary quite a bit. Even more so, this is illustrated by the changes we've seen this year. Some countries with traditionally large participation numbers (Argentina, Australia, Luxemburg, Peru) have not send us a report this time; this reduces the total average participation and has an effect on the statistics. Turkey and Tanzania reported a reduced participation or none at all due to national circumstances beyond their control.

To arrive at a reliable estimate of the total number of participants, some statistics are needed. The average percentage of participating scouts and guides per country is found from figure 2. Of course, differences between countries exist. This average is used to calculate the number of participants from the countries that didn't report (see figure 1), using their total membership registered at the World Scout Bureau and the World Bureau WAGGGS. Despite the variations between countries, this average gives a reliable estimate because of the large number of countries involved. A similar approach is taken to estimate the number of involved radio amateurs and visitors. The whole number-crunching exercise is then repeated to arrive at the JOTI participation numbers. We are very much aware that participation details of JOTI stations are not always available to the National Organizers. However, of the 52 reports we received, some 40 did have these numbers and that was sufficient to come up with a reliable estimate. This leads to the numbers presented in figure 3:

<b>Scouts</b>	:	<b>JOTA</b>	<b>JOTI</b>
		<b>382976</b>	<b>27569</b>
<b>Guides</b>	:	<b>47024</b>	<b>2515</b>
<b>total participants</b>	:	<b>430000</b>	<b>30084</b>
<b>JOTA radio stations</b>	:	<b>8373</b>	
<b>radio amateurs</b>	:	<b>12560</b>	
<b>internet locations</b>	:		<b>808</b>
<b>visitors</b>	:	<b>50693</b>	<b>992</b>
<b>active countries</b>	:	<b>112</b>	<b>82</b>
<b>average relative participation per country</b>			
<b>for scouts</b>	:	<b>0.99 %</b>	<b>0.11 %</b>
<b>for guides</b>	:	<b>0.48 %</b>	<b>0.04 %</b>

Figure 3: Total participation in the 42nd Jamboree-On-The-Air and Jamboree On The Internet.

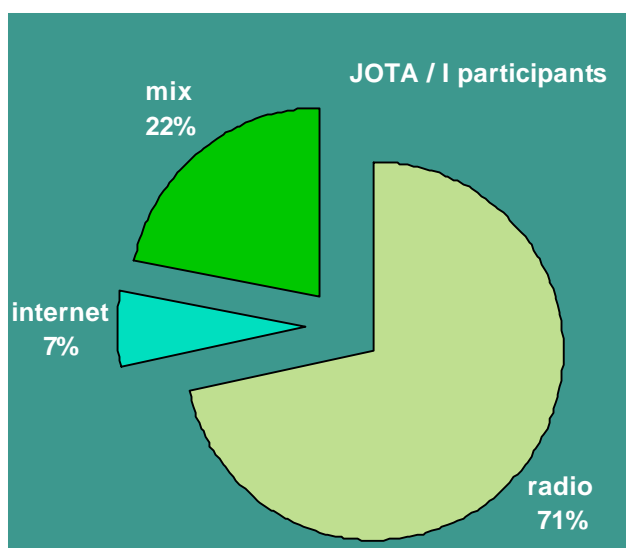

Figure 4. Division of JOTA / I participants.

As the next chapter will show, at the large majority of stations the use of internet was combined with the running of an amateur radio station. Compared to the 8373 radio stations, there were 808 internet-only stations reported: scout groups that took part in the JOTI event without using amateur radio. This is quite an increase over last year when 306 internet-only stations were active. Many more internet stations were active, all combined with amateur radio stations and this category is the one that grows the fastest. On the average, 4 computers are used per internet location. This is comparable to the average 3 to 5 different radio's used at a JOTA station. Figure 4 shows the activity of the participants: those that took part with amateur radio only, those with internet only and those scouts that operated a mixed station.

Some 89 % of the participants were scouts, the other 11 % were guides. This means an increase of guide participation compared to last year, when 7 % were guides. The number of participating countries, was stable at 112. The number of national JOTA organisers that sent their reports on a computer disk, via packet-radio or via email decreased a little this year to 40 %. It is a fast way of doing it. This allows electronic processing and saves a lot of time. We did note, however, a wider spread in types of programmes and formats used and this sometimes complicates the final editing. The electronic version of the report form that we have put on the WOSM web site was used many times but it didn't allow electronic editing because of the pdf format. To overcome this, we will try to make an electronic form available for the next JOTA that can be send via email from the WOSM web site on internet. A report form was used by 70 % of all the reports we received. It is a great help to receive your JOTA information in this standard way.

We are improving the electronic processing of illustrations, photographs and newspaper articles. Some organizers sent us photo's via email in jpeg format or similar. Whilst editing is very convenient, printing is not. The current

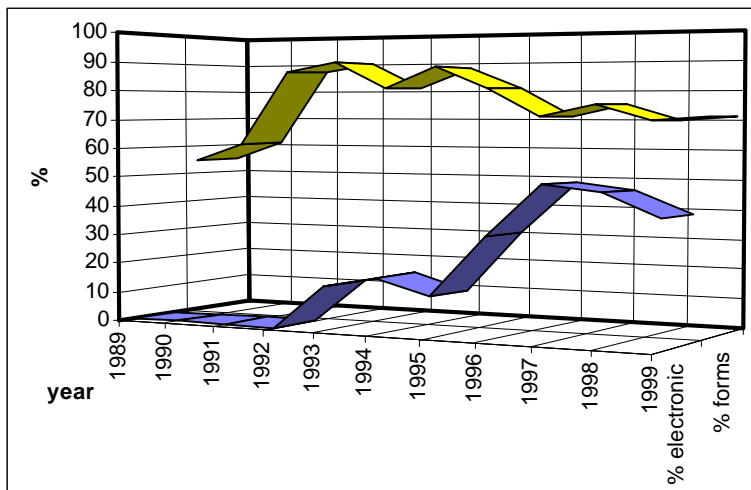

Figure 5. Reports sent digitally (% electronic), and reports containing a report form (% forms).

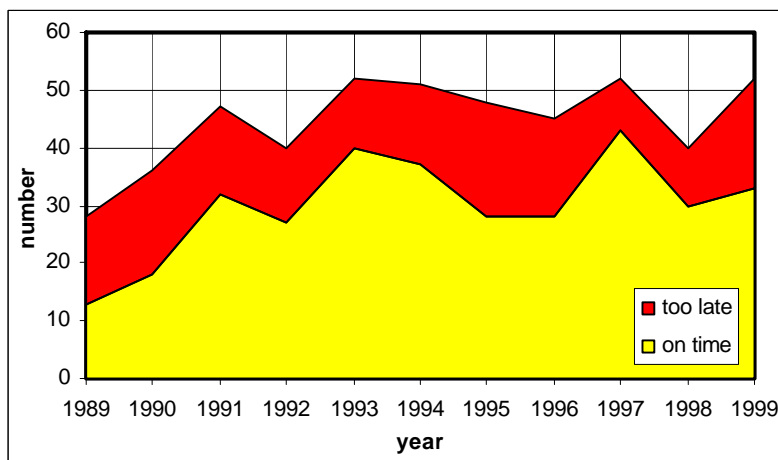

Figure 6. Number of national JOTA reports received.

since. The event soon became, as “World Scouting” reported, “part of the regular Scouting calendar in many countries”.

For the second JOTA, held over the weekend of 24 - 25 October 1959, VE3RT was not available so the Bureau used the facilities of Bert Coy, VE3GI, and the special call sign of VE3JAM. Once again, the staff shared the watchkeeper duties. Again, I cannot recall if we talked to any other scout stations. A report was not issued in those days and all correspondence has since been destroyed. However, I assume that we made some contacts, for the December 1959 issue of “World Scouting” stated that “it can now be taken for granted that the Jamboree On The Air is here to stay” for incoming reports showed that there were “a comparatively great number of scout stations” in operation despite the fact that “information (about JOTA) had not been spread as widely as could be desired”.

### **25 years ago: the 17th JOTA, 19 - 20 October 1974.**

World Report repeats the “basic recipe for JOTA success” first published in 1964: 1. Appoint a National Organizer - preferably a “ham”. 2. Give adequate publicity. 3. Plan ahead; do not leave everything to the last moment.

### **10 years ago: the 32nd JOTA, 21 - 22 October 1989.**

Solar flares occurred just before the JOTA weekend causing problems with long-distance communication. Aurora (the Northern Lights) was visible as far south as France. The bad radio conditions prompted many participants to start side activities like electronic-kit building.

In Australia scouts in the outback were taking part in JOTA as well; the radio networks of the Royal Flying Doctors Service, the National Telephone System and the School of the Air were all connected to the amateur radio network. And some satellite channels were made available by Aussat.

Les Mitchell, the JOTA originator, and his wife visited several JOTA stations in the Netherlands for which they drove nearly a thousand miles. “A thousand miles of friendship”, Les concluded.

The Polish amateur radio organization celebrates its 60th anniversary. Amateur radio was introduced in Poland in

(affordable) printers are not quite suitable to reproduce photo's in an adequate quality. However, if we are able to produce a fully electronic version of the World JOTA Report, these problems will be history.

The total number of National JOTA reports received was 30 % up over last year. What is problematic is that some 36 % of the reports arrived after the deadline, the main reason why we can't produce the World report any sooner or shift the deadline to an earlier date. We hope that an increased electronic processing and the use of email will improve that. A big thanks to those NJO's who did send us their JOTA reports and to those who didn't, we hope to see yours next year.

*A complete overview of 35 years JOTA history has been compiled by Len Jarrett, the former World JOTA Organizer: "The JOTA story, 35 years of Scouting's Worldwide Jamboree-on-the-Air". From Len's book, we read the following:*

### **40 years ago: the 2nd JOTA, 24 - 25 October 1959.**

The first JOTA had been held in May 1958, but encountered problems with various radio contests being held at the same time. Since we were newcomers, we decided to change the timing and after much searching, Les suggested the third weekend in October as being relatively free of other events. And there, with but one or two exceptions, we have stayed ever



1922 by scouts, making the first contacts with a spark transmitter. From Sri Lanka blind scouts went on the air with Morse code and a transceiver with voice indicators for the various functions. In Wales a cub scout asked his radio operator to send the word “Supercalifragilisticexpialidocious” in Morse code. The receiving station, however, could not pronounce it. Richard Middelkoop, PA3BAR, takes over the pen as editor of the World JOTA Report.

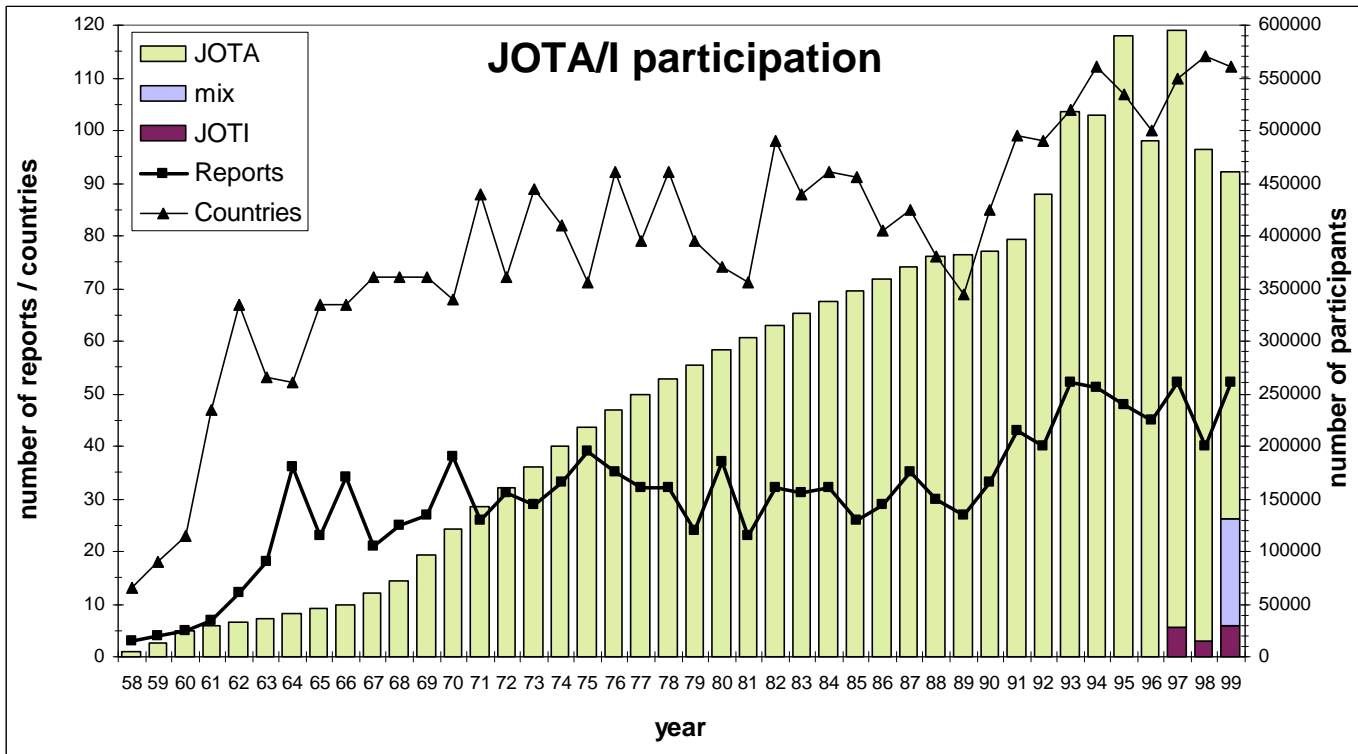
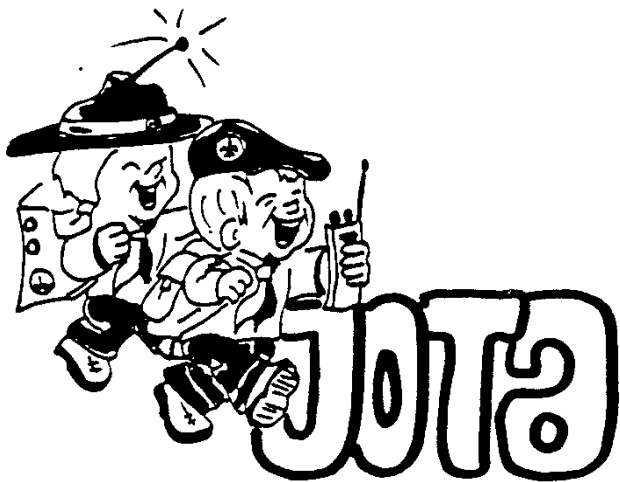

Figure 7: JOTA participation since the start in 1958. The number of participants is shown as a column, related to the axis on the right hand side. The two lines show the number of countries involved and the number of National JOTA reports received by the World Scout Bureau. These lines correspond to the axis on the left hand side.

Figure 7 presents you the overview of the JOTA development over the years. For the last few years we have included the numbers of scouts taking part in the JOTI and in mixed JOTA / JOTI stations. Some countries have long-standing experiences with the JOTA, others just started recently. When preparing for the next one, remember that there will always be scouts and guides for which the 43rd JOTA is **their first**.



# 4. The millenium adventure of John Bont

The last JOTA of this millenium entailed the following exiting communications game. For this game scouts needed:

- a JOTA radio station capable to communicate with other JOTA stations, preferably on the HF bands.
- A PC connected to the internet or a radio contact with someone that operates such a PC.
- A printer connected to the PC.
- A piece of yellow paper, letter size or A4 size.
- A similar piece of blank, white paper and a pencil to make notes.
- Scout map reading skills.
- Ingenuity and creativity.

Scouts could take part individually, in patrol units or as a group.

The needed to follow the story of John Bont and carry out the instructions that he receives.

John Bont is the special agent of the Bureau of Information and Valuables (BIV). For his last mission of this millenium, John has to recover vital information that has gone missing. BIV suspects it is hidden on a non-populated island, somewhere. The Bureau has arranged that John is airlifted to this island; he is dropped by parachute at point A (253472).

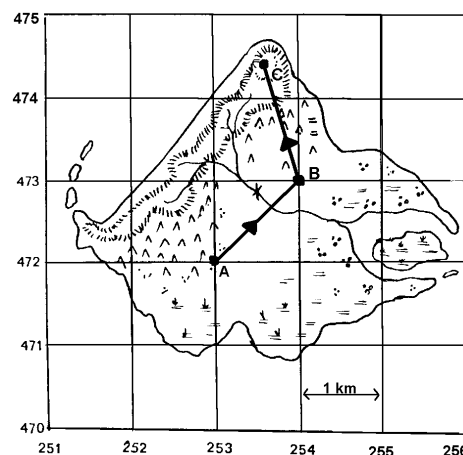

And this is what John's route looked like on his map.

After his safe landing, John Bont takes his compass: he has to walk 1.4 km in the direction 45 degrees. John quickly walks in a straight line and arrives at point B (plot his position on the map and note the map coordinates). Here at B he is able to use his radio (why?). First he makes contact with HB9S and asks for a set of 4 numbers. John knows that in case he cannot reach HB9S, he can also ask another radio station for this information. It may take a while before he finds someone who has these numbers, but he keeps trying.

Meanwhile John switches on his laptop and connects it to his gsm telephone. He makes contact with internet. He starts his favorite search engine and searches the entire internet for the keywords "**BIV mission code**". With some patience John finds a web page that BIV has prepared for him. The page shows an addressgroup. John carefully notes down this address information.

Via his radio he also received the 4 numbers from HB9S, passed on to him via another friendly radio station. He marks them as group Y. The address from internet he notes as group X.

Quickly John packs up his gear and rushes another 1.6 km in the direction 350 degrees. This is point C (mark this on the map and again note the map coordinates). At C he finds an old smugglers cabin with a PC. And yes, the PC is still working. Would this be the key to the lost information? John's heart beats fast as he types the following address into the PC's web browser: `http:\\www.[addressgroup X][4 numbers of group Y].htm`.

The mysterious web page appears on the screen. Yes! John pushes the print button but in his enthusiasm forgot to switch the printer on. He puts the special yellow paper in the printer and tries again. Yes, he's got it !!

John Bont carefully folds the paper and puts it in his pocket. Mission accomplished. He walks outside and finds a shady place under a tree. He opens up his lunch box to find out what BIV has prepared him for lunch.....

The solution:

HB9S transmitted these four numbers: 7428. Not only during regular contacts but also at the prescheduled times. And scout radio stations passed the numbers on to others as well.

With a little luck you found the "BIV mission code" on a web page in Spain (with a copy on the WOSM server in Geneva if you wanted to make it easy on yourself): the code said: `www.qsl.net/pi4ris/`. Thanks to Carlos Martin Ugalde of Madrid for putting up the special web page. So, all together, you needed to go to the web address: `www.qsl.net/pi4ris/7428.htm` to find a beautiful JOTA certificate that you could download and print. Thanks to Sjaak van Dam of the dutch Radio Interested Scouts who put up the certificate web site for us.

As the page counter showed, 38 scout groups were able to find the John Bont certificate. Mainly from Luxemburg, United Kingdom, Netherlands and United States. Not a large number, but enough to evaluate the game and maybe offer a similar one next year.

# 5. JOTA goes digital.....

Digital communications are increasingly important in the JOTA event. Not only do youngsters know how to operate computers, the wide-spread use of internet and the amateur packet-radio network allows them to effectively communicate with scouts anywhere in the world.

One of the messages that went out over the world-wide amateur packet-radio network was the speech of Pro. Setaporn Kusripituk, the Director General of the Post and Telegraph Department in Bangkok Thailand:

*Date: Sat, 16 Oct 99 05:38:00 UTC*

*Message-ID: <218@HS0AJ> (5574@PI8AWT)*

*From: HS0AJ@HS0AJ.#PTW.BKK.THA.AS*

*To: JOTA@WW*

*CQ CQ CQ Scouts and Hams,*

*Welcome you all to the World's 42th JOTA. This is the 2nd time that Thailand joins this great event. It's my honour to be here with you on behalf of the General Director of the Post and Telegraph Department.*

*(.....) To make good decisions in life , not only depends on experiences, but also on the Data and Information you get and collect. (.....) Amateur Radio is another best channel that can bring you knowledge, data and information that will be very useful for your life. (.....)*

*May I thank the Physical Education Department who makes this great event be true, especially Dr. Sasithata Pinchaicharnnarong E21BHV, director of the 20th World Scout Jamboree in Sattahip, Thailand, and all the hams who are contributing to this event.*

Many scout groups posted messages on the radio network prior to the JOTA weekend:

*Date: Sat, 09 Oct 99 11:31:00 UTC*

*Message-ID: <58010@ZS6ERB> (2769@PI8AWT)*

*From: ZS6HWC@ZS6ERB.ERJ.GAU.ZAF.AF*

*To: JOTA@WW*

*Subject: CQ ( NIGEL SCOUTS )*

*HI TO OUR SCOUT FRIENDS,*

*WE WOULD LIKE TO MAKE, MANY PEN FRIENDS AROUND THE WORLD AS WE CAN,SO PLEASE SEND YOU REPLY TO ABOVE PKT ADDRESS,WE WILL BE TAKING PART IN THE JOTA WEEKEND ON,HF VHF AND UHF +PACKET.*

*HOPE TO MEET YOU ON THE AIR,ALL THE BEST FROM RSA AND GOD BLESS, TILL SATURDAY 15TH & SUN 16TH OCT*

*BY NIGEL SCOUT GROUP SOUTH AFRICA*

*73 - CHRIS, ZS6HWC @ ZS6ERB*



Whilst others put out the messages composed by scouts and guides on the spot, live on air during the JOTA weekend:

*From Brown Owl Glenis*

*Date: Sun, 17 Oct 99 15:14:00 UTC*

*Message-ID: <25102@GB7DEO> (5903@PI8AWT)*

*From: GB5SG@GB7DEO.#32.GBR.EU*

*To: JOTA@WW*

*Subject: Catherine and Rebecca, Staines, UK*

*Hi, It's Catherine and Rebecca from 5th Staines Guides!*

*We both go to staines swimming pool. We are both 11. Rebecca has 1 sister. Catherine has a brother and a sister. we both like S Club 7. Rebecca has just done life saver stage 1 and 2, and water safety stage 1. Catherine has just done emergency helper. Today we have been doing morse code and making our own telephones. It's excellent!*

*What's the weather like where you are? Here it's sunny and windy.*

# 6. JOTA in print....

The JOTA is a major public-relations event for the Scout Movement as well. There is a large number of visitors that gets acquainted with JOTA and Scouting each year. The event also catches the attention of local and national authorities, as they are often asked to deliver the official national opening speech. Add all the media coverage of the JOTA to that and you have ample opportunity to promote Scouting.

PFADITREFFEN PER FUNK

## Via Äther

### in die Welt

SKAUTI V ÉTERI



□ **CALLING THE WORLD:** Scouts Eoin Keenan (11), Michael Conville (13), Mark Connolly (11) and Kevin Haafin (12) taking part in 'Jamboree on the Air'

### Scouts honour, they really did make space contact!

**John Lawrence**

THE Bayside Scouts Troop in Sutton went global this weekend when their members took part in a world-wide amateur radio event.

The scouts contacted their counterparts in Ireland, England, Europe and America in a 48-hour communications marathon known as the 'Jamboree On The Air'. Their radio base was set up Friday night at their scout den and their station EI 4 BST (Eire 4 Bayside Scout Troop) stayed on air until last night.

Using short wave or "ham" radio signals they sent and received messages from other scout groups all over the world.

Last year, they made contact with the Mir Space Station. "We contacted astronauts on Mir using a the radio and a computer and typed a brief greeting to them," said Sean O'Sullivan, a member of the group.



42th Jamboree On The Air

### งานชุมนุมลูกเสือทางอากาศ



**Van een onzer verslaggevers**

WILLEMSTAD - Ruim 350 padvinders hebben ditmaal het hele weekeinde door deelgenomen aan de Jamboree On The Air en de Jamboree On The Internet (JOTA/JOTI '99) die op de Universiteit van de Nederlandse Antillen plaatshad. Behalve door de padvinders die op het campusterrein in reusachtige tenten van de marine kampeerden, werd het evenement ook nog door ongeveer 1000 andere scouts en burgers bezocht.

Bij de JOTA/JOTI ging het er weer om duurzame vriendschap te sluiten met padvinders elders in de wereld, waar de activiteit eveneens is gehouden. Milaishkelly Regales (14) heeft al via de

# „Füchse“ per Funk angepeilt

## Pfadis knüpften weltweit Kontakte

**Bad Sassendorf. (rkr)**  
Die Georgs-Pfadfinder aus der Bonifatius-Gemeinde in Bad Sassendorf auf „Fuchsjagd“: Anstelle zur „Büchse“ griffen die Pfadis am vergangenen Wochenende beim „Jamboree on the Air“ allerdings zu Funkgeräten.

Alljährlich treffen sich Pfadfinder aus aller Welt an diesem Tag auf Kurzwelle. „Wir haben heute 500 000 Pfadfinder im Äther“, erläuterte Reinhard Müller und seine Freunde vom Amateurfunkclub Soest stolz.

Müller, der neben seiner Vorstandstätigkeit bei den Pfadfindern ein passionierter Amateurfunker ist, war auch diesmal maßgeblich an der Organisation beteiligt. So konnte er zu Hause im Bruchgut 20 Pfadfinder aller Stufen

begrüßen. Auch Vorsitzender Hugo Elscheidt und die Leiter Anne Klösener und Markus Heymann ließen sich von der Funkeuhporie packen und gehörten zu den gespannten Zuhörern bzw. Zuschauern.

Höhepunkt des Nachmittags war dann zweifellos die „Fuchsjagd“. Mitglieder des Funkclubs Soest hatten im Wintzigerode-Park vier Sender versteckt, die es durch Anpeilen aufzuspüren galt. Kleine Preise sorgten für Ansporn.

Am Abend konnte dann mit Spezialgeräten die Verbindung zu einem dem Internet ähnlichen Netz geknüpft werden. Dadurch hatte jeder die Möglichkeit, am Computer mit anderen Pfadfindern aus aller Welt zu kommunizieren.



Sebastian Saxer hatte bei der spannenden Funk-„Fuchsjagd“ im Frelherr-von-Wintzingerode-Park einen ausgelegten Sender aufgespürt.

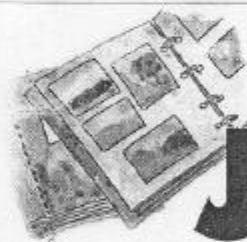

## iz naših ljetopisa

# JOTA-JOTI '99

Ovogodišnja akcija JOTA-JOTI održala se za vikend 16. i 17. listopada. Zbog vremenskog tjesnaca u koji stalno upadamo zbog angažiranosti na više strana, a i zbog određenog previda akciju nismo pripremili u obujmu u kojem je to trebalo biti. Zaključak je jedino bio da se nećemo priključiti na JOTA - jer nemamo radio stanice, a klub radio - amatera nismo htjeli ponovo gnjaviti, ovako nesprenni. Stoga smo odlučili pozvati jedinice da se putem Interneta u SSZ-u priključe na JOTI u određenim vremenskim intervalima (subota i nedjelja popodne do navečer). Tako smo i uradili.

Nenavikli na takvo komuniciranje trebalo nam je određeno vrijeme dok se spojimo na servere i krenemo u komuniciranje sa skautima svijeta. U akciji su sudjelovali članovi Brodosplita i Splita, dok su Jadranovci imali posla oko pripreme svog natjecanja JING-JANG pa su unaprijed najavili svoj izostanak, a članovi Meja su najavili da će se priključiti preko vlastitih PC-a i priključaka na

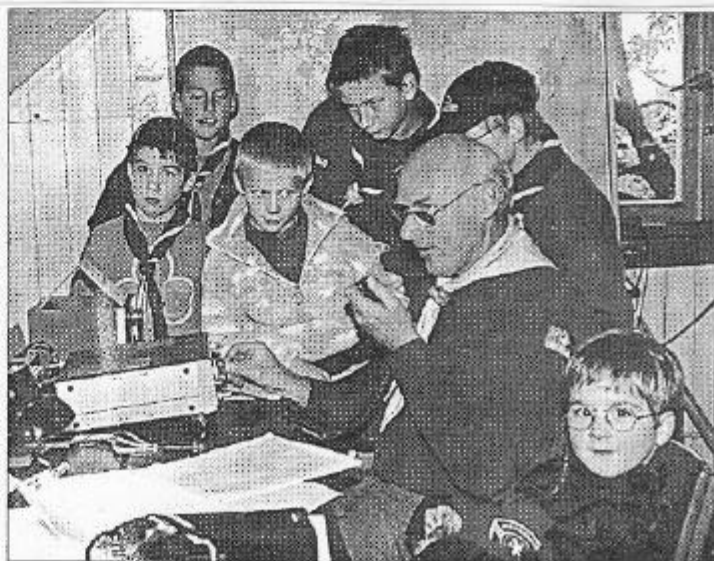

Zeigte seinen Mit-Pfadis wie es gemacht wird - der zweite Operator Dieter Borg hatte viel zu tun.

Foto: Pamingner



42<sup>nd</sup>  
Jamboree  
on the Air

# JOTA

# 1999

October 16-17

JOTA & JOTI

## 今年は両方エンジョイ!!

10月16日0時〜10月17日24時まで48時間開催!!

JOTAは、スカウトなら誰でも参加できる。世界中の兄弟スカウトたちと、電波を通じて友情を深める絶好のチャンス。

日本では、免許を持たない人の交信は禁止されているため、アマチュア無線の免許を持っていない人は、参加局の交信を聴取することで参加する。所属する隊・団・地区・県連盟などのプログラムに参加するほか、一般のアマチュア無線局の協力を得て参加することもできる。

終了後は記録をとりまとめ、所定の様式で報告書を作成し、切手を貼った返信用封筒（ハガキが入るサイズ）とともに、日本連盟宛に提出する。参加者は、世界スカウト事務局発行の参加証が送られてくる。

ジャンボリー・オン・  
ジ・インターネット

今年で4年目を迎えるJOT

Iは、各国の標準時間でJOT Aと同時に開催される。

参加方法は、コンピュータのハードウェア、ソフトウェア、インターネットへのアクセスがで

**WILLEMSTAD-** Por bisa ku UNA a keda konvertí den un kampercentrum di Scouting den wikènt di 15, 16 i 17 di òktober 1999.

Gruponan di Scouting Antiano a kambia UNA den un berdadero lugá di patvinderij.

Den e wikènt ku a pasa tabata wikènt di Jamboree on the air i Jamboree on the internet.

Ta asina ku semper den òktober tin un wikènt stipula kaminda tur miembro di patvinderij di WOSM i WAGGGS

## SCOUT JAMBOREE

### GOTA, JOTA, WOTTA great bunch of scouts!

On Saturday, 16 October 1999, the VE3JW radio station was visited by a local group of scouts who were participating in JOTA '99.

Jamboree-On-The-Air is a once a year event that takes place in October and includes scouts all over the world. This event is under the control of the World Scout Bureau in Geneva, Switzerland, and although the main purpose is world wide radio communications, it also includes other activities.

The Seventh Orléans Cubs, being led by "Akela" Doug Zahodi, were all eager to communicate with other groups taking part. The first such group was just across the river, camped out in a Gatineau park. Two-metre contacts were conducted in both French and English on a simplex frequency. Mike shy, the responses were quick and short.

# Jota/Joti 1999 eksito rotundo na UNA

## بمشاركة ١٢٠ كشافا ومرشدة

# ٥٠٠ اتصال لاسلكي يجريها المخيم الكشفي



■ جانب من فعاليات المخيم

ومن أبرز انطباعات المشاركين عن المخيم: ان التدريب العملي لكافة المشاركين على استخدام أجهزة اللاسلكي وتدريبهم بالنداءات والرموز والترددات المستخدمة قبل مشاركتهم في المخيم أتاح لهم تفهم فكرة الاتصالات اللاسلكية وسبل الاستفادة منها والتعامل مع الأجهزة الخاصة بها.

ويضيف البعض: ان المخيم كان فرصة لهم وناقذة عبر العالم لتعمية العلاقات والصدقات وتعزيز روابط الأخوة وهو اطار عملي لتبادل الخبرات والتجارب وتنمية للهوايات التكنولوجية وتطبيق عملي لبعض النظريات العلمية في المدارس وفرصة للحصول على شارة هواية جديدة واختبار حقيقي لدى تأثير الكشافة وانتشارها في العالم واعلام غير مباشر عن الحركة الكشفية والارشادية في العالم.

اكتوبر ١٩٩٩ في تمام الساعة الرابعة بتوقيت السلطنة وقد بلغ عدد المشاركين ما يزيد على مائة وعشرين كشافا ومرشدة من مختلف المراحل والفرق الكشفية والارشادية في محافظة مسقط وقد قاموا خلال المخيم بإجراء ما يقرب من خمسمائة اتصال حتى الان مع ما يقرب من تسعين دولة في العالم أغلبها محطات كشفية.

وكان من أبرز الاتصالات أيضا ما حققه الكشافون والمرشدات مع المحطة الخاصة بالمكتب الكشفي العالمي في جينيف واستطاعوا أن يحصلوا منه على الأرقام الأربعة السرية التي تحل لغز اللعبة العالمية المعروفة باسم جاك بوينت، والتي ينظمها المكتب بين أكثر من مليون كشاف ومرشدة مشاركين في هذا الحدث العالمي كما استطاعوا أيضا تحقيق اتصال مع بعض المحطات الكشفية العربية الشقيقة في كل من الكويت والسودان ولبنان.

## Skauti budú cez víkend sedieť pri rádiách a pozdravovať kolegov zo zahraničia

**NOVE MESTO NAD VÁHOM (PRE SME - bo)** - Tretí októbrový víkend už tradične patrí skautom celého sveta. Počas celého víkendu si skauti zo všetkých svetových strán posielajú vzájomné pozdravy prostredníctvom rádioamatérskych staníc. Títo sobotu a nedeľu to bude už 42. ročník, známy pod názvom Jamboree on the Air - Jota, ktorého sa od obnovenia skautingu v Československu v roku 1990 pravidelne zúčastňujú aj slovenskí skauti a skautky. Ako prvá si so zahraničím začala dopisovať rádiostanica z Nového Mesta nad Váhom, ktorá bola vtedy priekopníčka a zároveň zriadila tak nový odbor v Slovenskom skautingu, ktorý dovtedy nebol. Spolu s Novým Mestom sa do celosvetovej akcie po-

stupne zapojili i ďalšie slovenské rádiostanice. Tretí rok sa symbolickej dopisovacej víkendovej akcie zúčastňujú i rádioamatérske stanice Zväzu skautov maďarskej národnosti na Slovensku. O tom, že vo svete je o Jamboree on the Air - Jota veľký záujem, svedčí štatistika uverejnená v zborníku World Jota Report vydávaná každoročne ústredím svetovej skautskej organizácie v Ženeve. Mínuloročného 41. ročníka sa zúčastnilo 10 180 rádiostaníc so 16 687 operátormi, pri ktorých počas víkendového pozdravovania spolupracovalo 468 106 skautov a skautiek 116 krajín sveta. Najväčší počet rádiostaníc vysielala z Holandska, Indonézie, Mexika a zo Spojených štátov amerických.

## Pfadis plauderten per Funk

**PERCHTOLDSDORF.** - Auch heuer nahmen die Pfadfinder am weltweiten Funk-Treffen „Jamboree on the air“ teil und errichteten ihre Funkstation auf der Teufelsteinhütte.

Vier Mädchen und sieben Burschen versuchten fremd klingende Sprachen zu entzif-

fern. Aber besonders großen Gefallen fanden sie an der Plauderei der beiden Funk-Amateure „OE1FFS“ (Fritz an der Mödlinger Funkstation) und dem Hobbyfischer OE3RPC aus St. Pölten. Die weitest entfernte Station befand sich in Sao Paolo in Brasilien.

# Spejderlejr »on the air«

Dwunaste urodziny

## Spotkali się krótkofalowcy

Z okazji 12. rocznicy powstania 141. Bydgoskiej Drużyny Harcerskiej „HABAS”, w Półku koło Koronowa spotkało się ponad 150 harcerzy z regionu kujawsko-pomorskiego.

sie fal krótkich. Z Półka możemy połączyć się praktycznie z całą półkulą i mamy za granicą wielu znajomych – powiedział pfm Daniel Roguszcak, drużynowy 141. BDH.

### 第4回JOTI

#### ジャンポリー・オン・ジ・インターネット

無線のかわりにインターネットを利用して情報を交換し、友好を深めることを目的に、JOTAと同時開催されます。詳しい情報は日本連盟のホームページをごらんください。

— 日本連盟ホームページ —  
<http://www.scout.or.jp/>

# Scouts massaal naar JOTA/JOTI '99

# JOTA 1999 ali Tajna misija agenta Bonta

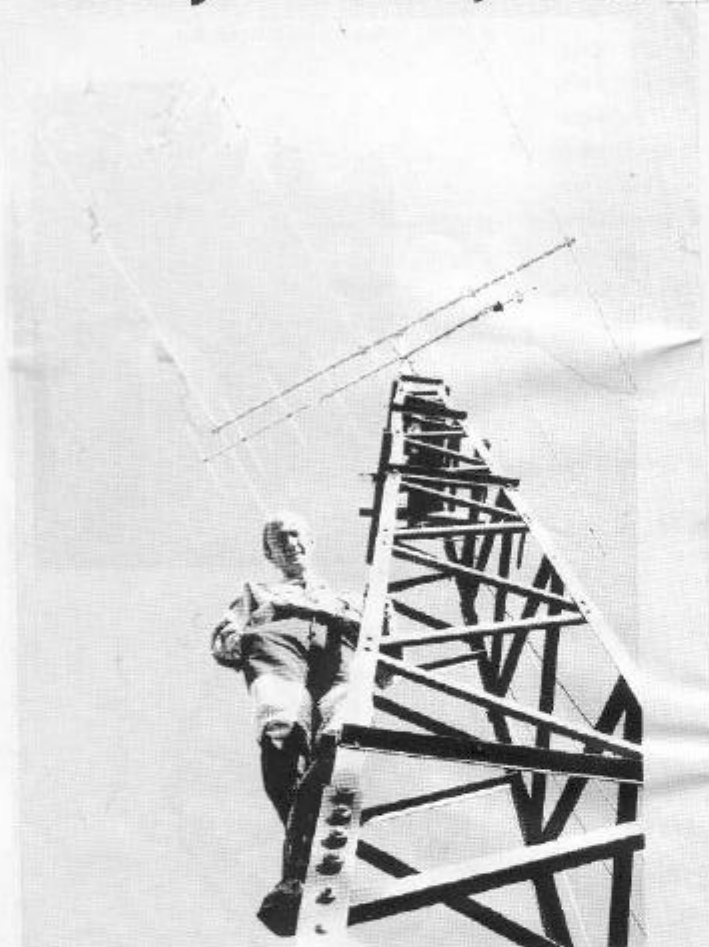

"Živijo mama," in "Grem ven, mama, na JOTO," sta bila stavka ki sem jih še izrekel in v isti sapi še dodal: "se vidimo v nedeljo ... enkrat."

To pa je bilo tudi vse. V jeklenega konjička modernega kavboja natpam še nekaj stvari in gremo v Cerknico. Zakaj? Preprosto zato, ker je pred mano sodelovanje na Zletu v zraku ali JOTA-i, najštevilnejšem skavtskem dogodku, pod okriljem WOSM-a. Letošnja JOTA

je bila že 42. po vrsti in začela se je prav v stilu Jamesa Bonda ... no ja Johna Bonta, skrivnega agenta Urada za informacije, ki je bil na ponovni tajni misiji na nekem otoku. Preko radijskih postaj, ki so sodelovale v JOTA-i in potem še preko Interneta, smo udeleženci po naših močeh pomagali agentu WOSM-a, da je razvozlal uganko in se srečno vrnil nazaj v Ženevo. Priznati je treba, da je bila zamisel o sodelovanju JOTA in JOTT

**KFUM-Spejderne i Tårnborrg sørgede for den danske åbning af JOTA, Jamboree On The Air. 500.000 spejdere fra 100 lande mødtes i weekenden på kortbølgeradio**

**SVENSTRUP:** Svenstrup Bjerg var ikke til at kende i weekenden. Den ene antenne efter den anden med hvad der fulgte med af liner og kabler omringede KFUM-spejdernes højtbeliggende klubhus på Svenstrup Strandvej.

Indenfor fortsatte det systematiske virvar af kabler, der mundede ud i alskens meget teknisk udse-



↑參與童軍大集營的男女營員，充分利用機會在“流動網絡巴士”內與全球的營員交換心得，建立友誼。



## Scouts participate in Jamboree

The 37 Springvale Scouts recently participated in the International Jamboree on the Air for scout groups world-wide. The jamboree entails the setting up of an amateur radio station with the aim to contact other scout groups in other parts of South Africa and the world. The scouts used call sign, ZS37SS and learned about radio electronics and communication. Ray Webber, a radio amateur with the call sign ZS6RSW, helped the scouts to set up the radio station. Here he is showing Lawrence Lagaay how to use his self-built crystal radio.

Padvinders met de tijd mee



# 7. Reports from countries

Note:

- ◆ Indicated per country you will find the numbers of participants, of JOTA radio stations, of internet stations **not** using amateur radio and the number of different countries that were contacted. A question mark “?” indicates that the numbers were not given in the report.

## Algeria (7X2)

participants:	18
stations:	
internet:	1
countries:	9

The national amateur radio association in wrote us that they set up a special station 7X2JOTA at an international scout camp near Alger. It was situated in a large forest. One of the young leaders, Hichem, who worked all night at the station, was noted by a french security patrol who contacted him and wished him good luck with the activity.

## Austria (OE)

participants:	50
stations:	11
internet:	0
countries:	32

“A good premiere is only possible after a lousy dress rehearsal”, is an old saying that I have to remember, writes Walter Nowakowski. During the preparations we only got cancellations of the groups that were supposed to work with us. But in the end, group 88 (!) Sankt Georg



The mountain view at OE3XPU.

showed an interest in the event. A group that had no previous contact with amateur radio. The station was set up in the small town of Blumau. The place was almost entirely part of the Burgenland Province, but 2 houses belong to the Niederoesterreich Province, which is a different call sign district. A small creek indicated the borderline.

Robert OE3RTB was able to “open” the window towards Japan at the right moment and the JA, JH stations came flying into his qth in Laa an der Thaya.

One of the most loyal stations again joined the party, the Perchtoldsdorfgruppe with the call sign OE3XPU. They thought that the 2 m band was not well used. Then again, they transmitted from the top of a mountain, whilst most JOTA stations were somewhere in a valley. From Gmunden a JOTA station was run by Josef OE5JFL.

Noteworthy contacts were with scouts in the Ukraine that spoke very good english and with scouts in Morocco. The latter ones didn't want to speak to the girls. Scouts in Norway described the “Northern Lights”.

## Belgium (ON)

participants:	?
stations:	?
internet:	?
countries:	?

Jin Beveren, in co-operation with radio-amateurs of Sint-Niklaas ON4SNW/P wrote us: On the last autumn-meeting with 4000 leaders we were confronted with radio-amateurism within scouting. The radio-amateurs of Sint-Niklaas had settled their antennas on our campsite in Gouw Waas. They wanted to find a group to work with for the next Jamboree on the air. Because of that we arranged with our 3 leaders to offer 3 weekends: building up a tower, jota, pulling down the tower.

On Saturday 16/10/99 we thought to build the tower to an height of 14 meters to have a good ATV-signal. But the biggest antenna reached the height of only 10 meters Next year we'll do better. For the tower we used stakes of 8 and 6 meters in square construction. When we stood on the platform we had a beautiful over-view of the neighbourhood and you could see the church of our village. It was a little bit dangerous because of the strong wind above, so it wasn't very suited for persons with fear of heights.

The funny thing about our Jota-weekend was the mussel-weekend of the local scout-group. We, as the eldest group of 21 persons are obliged to help in these



7X2JOTA: hello this is Algeria calling....



groups whenever is necessary. So we had two activities that day: the mussels and the Jota. So half of our group was communicating with scouts around the world whilst the other half was cooking. We offered the radio-amateurs a free mussel-meal as a thank-you to give us this beautiful opportunity to take part in the Jota and I think the mussels tasted very well.

In the beginning it was very hard to learn the principles of radio-communication like: 'this is Oscar November Four Sierra November Whisky strook Jamboree on the air Seek you Seek you'. Several people were afraid to take the microphone and get in action. Especially the radio-alphabet wasn't very easy to learn, but after several tries some people got addicted like one of our leaders: Koen.

### **Bolivia (CP)**

participants:	1800
stations:	?
internet:	?
countries:	14

Camilo Zeballos wrote us that in JOTA 1999 radio fans and the bolivian amateur radio club worked together with their teams and know-how and so the participation of the branches explores and pioneers was numerous. Some contacts were made via the internet.

### **Brazil (PY)**

participants:	8000
stations:	274
internet:	0
countries:	12

Solemar Bordin reports that during 1999 all activities related to Radio Scouting suffered a lot of changes in Brazil. A National Team composed by people from all Regions of the country was created. Many seminars and courses were held during the year, including the following aspects: Ham helping in emergencies, Packet, Satellites, DXpeditions, and other. We officially started dealing with JOTA/JOTI in June, when a station set in a big camping first gave the official information about the activity this year. At the very same time the official Brazilian JOTA/JOTI web site was launched at [www.qsl.net/jota](http://www.qsl.net/jota). We also had a special edition of our newsletter "Radio Scouting on Focus".

PY2GJR from the Ramalho Scout Group 18/SP, a very traditional JOTA participant, report us that they manage to contact HB9S. PV8IG Ivanildo Gomes, member of our National Radio Scouting Team, met a friend he did not had heard about for over 20 years. We also had a big game for Scout Groups in which they received the information of what they had to do through the Radio and the Internet. Scouts should take pictures from the station and write compositions about their experiences in the JOTA/JOTI. They should also collect food supplies for charity, and in some hours we had about 8000 kg!



Belgium: a tower to be proud of.



A contact with history: the radio museum at the Montreal Tower.

This year the participation on the JOTI increased in a considerably way. Many chat rooms were created and a very interesting game, the JOTI Puzzle was created by a team from the state of Santa Catarina. In many sites there were hidden pieces of a nice puzzle.

### **Canada (VE)**

participants:	2899
stations:	49
internet:	6
countries:	28

Lena Wong (SC) reported the following: the 1<sup>st</sup> Valleyview



Scout Troop from Alberta had 20 participants. Unfortunately the reception was poor on the radio station and only two contacts were made. JOTI participants had contact with several countries and e-mail correspondence is continuing with groups in Borneo and New Zealand.

In Newfoundland the Fogo Island Cub Pack had a great weekend with 24 participants. The Cubs enjoyed JOTA as part of a two night sleep-over at the Lions Club. Part of the weekend was spent on crafts, games, an inside "camp-fire" and lots of singing. The inclement weather did not permit outdoor activities. A contact was made with the Polish JOTA organizer who was working from a portable station.

In Ottawa, the 7<sup>th</sup> Orleans Cub Pack participated with a group of 15 at the National Museum of Science and Technology where they were hosted by the radio amateurs staffing the radio display. They had a chance to speak French



Hello, this is VE2RIO, on top of the Montreal Tower. We have a great view here...

to a group camping just across the Ottawa River in Gatineau Park and earned their 'Je Parlè' badge. The Cubs were also able to work on their Space Exploration badge while visiting the space shuttle mock-up at the museum.

Whitby District in Ontario participated in both JOTA and JOTI with a total of 169 participants. The event took place during a District Camp. The local school board permitted use of their computers. Groups spent one hour at the radio and the computer. The rest of the time was spent on patrol challenges and compass games.

In Northern Ontario, the Sudbury District had a turn-out of 85 participating in both JOTA and JOTI. The event took place at a district camp where participants came to learn camping and communications skills. Venturers were present at the camp to help teach Scouts basic camping skills. Contacts were made with groups on all continents.

In the far north a Yukon Group of 40 participated in JOTA. Some of the Cubs and Scouts camped both nights. They had snow Friday night but otherwise the weather was great.

In Nova Scotia the 13<sup>th</sup> Sydney Scouts participated in JOTA. They did not have a great deal of success with broadcasting because of poor weather conditions. However, the event was enjoyed by the participants who learned a great deal about radio operations from the amateur who hosted them.

Finally, In British Columbia 11 participants of the 6<sup>th</sup> Roberts

Creek Sea Scouts had fun with JOTA. The troop enjoyed the event and are keen to organize a bigger one next year. They made several contacts in California and also heard about the earthquake which took place during the weekend.

Jean-Yves Ruault (ASC) writes us: la station nationale VE2RIO était sise une fois de plus a la Tour du Stade olympique a Montreal. La station était située dans l'observatoire de la Tour, ou défilent chaque jour plusieurs centaines de visiteurs, don't étaient des scouts étrangers, qui ont pu apprendre ce qu'était le JOTA. Nous avons un programme special pour les pionniers, qui comprenait les communications par internet et par radio. Nous avons installé, au pied de la Tour, un musée de la radio et des télécommunications, qui a vivement intéressé les participants.

### Chile (CE)

participants:	10160
stations:	80
internet:	0
countries:	13

The team in charge in Chile was put together of radio amateurs and internet specialists, writes Isabel Carreño. This worked out well, since both groups could complement each other. It was the first time that we

were involved in JOTI at a national level. All internet activity was combined with radio stations.

The operator at CE3JAM wanted to get some sleep at a given moment. However, the scouts were still enjoying the radio contacts. Still other scouts walked in, coming from the internet room where they had chatted with friends in Mexico and Brazil.

The electronic kit building was a great idea and the scouts were very enthusiastic about it.



## China Republic (BV)

participants:	1502
stations:	15
internet:	0
countries:	11

Like in past years, the JOTA & Internet Team organized the JOTA event. Scouts have a lot of fun in contact with each other through radio and internet. Most of the JOTA stations provide radio and Internet program at the same time. Scouts have the opportunity to learn Morse code, talk to other scouts via radio, surf on the internet, play computer games, etc. Some scout stations even provide merit badges program. Scouts can earn merit badges, like information technology, computer, radio, typing and so on.



BV0BSC: look, I have to put in this resistor, but where...?

The number of the station is decreased because an earthquake happened in Taiwan on September 21. The earthquake was considered the biggest one in the past 100 years. Still, the JOTA team managed to set up 15 scout stations around the country. Some of them include special earthquake theme program during the JOTA.

The BV0BSC scout station was set up in Taipei at the Hsin-Hua Primary School. The JOTA and internet team organized three events all together during the JOTA weekend, ie. The JOTA, Scout Fun Fair and Rover Scout Overnight Camp. Dr. Ming-Hucy Kao, Chairman of the Scouts of China, opened BV0BSC on Sunday morning and talked to each BV scout station.

BV0BSF was set up in Kwang-Shan Junior High School in Taitung. The station provided an overnight camping program for participants during JOTA weekend. There were 120 boy scouts and girl scouts attending the event. They set up the radio station and used the computer classroom in the school to take part in the JOTI.

At BV0BSV scouts could print the JOTA logo on their T-shirts by silk-screen printing.

BV0BSN scout station was set up at the Fu-Hsin Junior High School in Tainan. The school provided its IT facilities without conditions for participants to take part in the JOTI. About eighty-eight computers were provided and scouts used these computers to connect to the internet free of charge. According to their radio log book, they made some contacts with Japanese scout stations as well.

The scout station in Taichung city was the biggest scout station. They use three call signs: BV0BST, BV0BSX and BV0BSQ. A total of 882 scouts attending the JOTA. Scouts participated in different games and base activities and had the chance to collect all activities stamps in order to get prizes or activities awards, concludes Tim Kuo his report.

The scout station in Taichung city was the biggest scout station. They use three call signs: BV0BST, BV0BSX and BV0BSQ. A total of 882 scouts attending the JOTA. Scouts participated in different games and base activities and had the chance to collect all activities stamps in order to get prizes or activities awards, concludes Tim Kuo his report.

## Croatia (9A)

participants:	216
stations:	3
internet:	5
countries:	25

There was a major improvement regarding the last year's figures, including both the number of scouts that take part in this event and the number of countries that were contacted, reports Vladimir Jurkic.

Although the JOTI event was similar to the last year, there was an increase of almost 10 times in JOTA activities. The large improvement in the number of scouts who participated in JOTA event was the result of better planning and preparations for this year activities. Preparations started in August, when some of the JOTA/I material for the participation and with proposed activities were translated on Croatian language and distributed to all scout groups in Croatia. JOTA/I event was announced in the November issue of the bulletin "Bilten", which is the official bulletin of the Scout association of Croatia sent to all scout groups and scout leaders. One month before the event, radio amateurs and radio clubs were contacted to help in the forthcoming event providing technical assistance and radio devices.



The JOTA event was organised in three cities (Zagreb, Pula and Valpovo) where 3 scout camps were held specially for JOTA activities. The Scout Association of Zagreb organised a camp on the top of the mountain near Zagreb. The technical organiser for the city scout association was the scout group 15. sè "Tornado" with the help of radio amateurs from the radio club KMT "Dubrava".





During the JOTA weekend a camp was built in the mountain house Glavica on Medvednica Mountains. Beside the JOTA activities, radio amateurs have organised a short course on radio communications and demonstrated the use of hand radio devices (walkie-talkie). Later, cub scouts were happy to try to communicate between themselves using those hand radio devices (walkie-talkie).

The scout group "Iovallios" from Valpovo took part in JOTA event after they have paused the last year. The call sign of the radio amateur club is 9A1KDE. They have organised a small camp during the JOTA weekend in the forest near their village. For most of their scouts, this was their first contact with the world of radio communications, so the radio amateurs have organised a short course on basic knowledge of the radio communications week before the JOTA weekend as a part of their technical preparations. The younger scouts were little embarrassed and shy at the beginning, but after they talked with 9-year



Croatian JOTA camp: the kitchen staff at work.

old cub scout James from England with nice and good radio reception, there was much easier for them to take the microphone and tell few words about themselves, their scout group and scouting in Croatia. They have also talked with James about the last part of their callsign (NLO), which in Croatian language means "UFO – Unidentified flying object (Nepoznati leteći objekt). Scouts from Valpovo want to mention the contact with Peter from Sweden. At the beginning, they had some problems with the spelling of the names, especially with the spelling of Peter's scout group name "Ransbergsherrgaard", which is strange and hard to spell in Croatian language. On the other hand, Swedish scouts had also lot of problems in spelling Croatian names and the name of the scout group, which is strange for Swedish language. There was lot of fun while talking to the Portuguese scouts from Lisboa, Nuña and 11-years old Andrea, who wanted to write down all the names of contacted scouts from Croatia.

Sea scout group "Uljanik" from Pula took part in JOTA activities for the fifth consecutive year. The established radio station have used economical energy source (diesel electricity generator). The Sea Scout Centre in which JOTA was organised is situated on a remote and unpopulated small island in the Adriatic Sea. But despite the bad conditions for radio communications, the camp was a great opportunity for gathering a larger number of scouts who had a chance to learn and to try radio communication for almost two days. It was a great chance for the youngest scouts to learn something about radio devices and to talk to other friends from around the world. During the JOTA weekend, scouts participated in workshops where they got familiar with the working practice, radio station devices, and communication rules. On Sunday, a scout competition in communication skills was held. Different patrols competed in traditional scout communication skills such as communication with Morse and flags (used



Concentration at the JOTI screen.

on sea) and they took part in a communication quiz. The world map was also made so that every established contact was marked with a pin on it. The Vice-chairman of the Scout association of Croatia opened the JOTA camp. The contact with David from Whitewater Scout Group in Pretoria in South Africa was one of the most interesting contacts. As cub scouts didn't know English very well, they decided to sing few songs to scouts from Setro Montalvo group in Spain and to Peter from Narstad in Norway. The Spanish did the same – they sang few songs on their own language. Scouts from Pula also contacted scouts from Tunis, which was their first contact with scouts from north Africa. They had a nice and long talk with Slovenian scouts from Kobanci, especially with their operators Dubi and Slemen, who were interested to visit Croatia. Slovenians proposed to make an international exchange of scouts and camps – Slovenians will

come to Pula to the Sea Scout Centre in the summer, while scout from Pula will spend their winter holidays in the mountain house in north Slovenia. A pleasant conversation was made with Italian scouts from Vicenza. They were surprised when the Croats told them that they have a gemini scout group near Vicenza, in Marano Vicentino, with whom they have organised a summer camp in the mountains of north Italy in 1994 as a part of the huge project of



camps "Tre foglie". Scouts from Belgium were interested in the Eurostep project, which is organised in the Sea Scout Centre and lead by the scouts from Pula. The funniest situation happened when they have talked to a Belgian guide. She was surprised when they told her that "they have never seen a radio or a television" – and she believed it. Fortunately, she didn't believe that scouts from Split "eat little children while the dragons fly across the sky and the sulphuric steam burns from the ground". Ihsan from Ankara in Turkey wanted to know everything about the World Jamboree in Chile in 1999, on which some of the scouts from Pula participated, both as participants and members of International service team. He also wanted to know how much scout leaders are paid in Croatia. Scouts from Split make a joke telling him they have a wage of more than 3000 DEM per

month! The Portuguese wanted to have our Scout laws and Scout promise on Croatian language because they were making a collection.

Scout groups communicated with other scouts through e-mail and mailing lists, but the most popular was IRC (Internet Relay Chat). Through IRC channels scouts were able to communicate directly with other people from all over the world. Only one scout group participated in both JOTA and JOTI event (Scout group "Iovallios" from Valpovo), but PC computers and radio stations were placed on different locations so they have not been able to communicate simultaneously both by Internet and radio waves.

As more than 10 scouts were using the same PC computer at the same time, a precise log of all contacts with the names of the contacted scouts and scout group was not made. For the new scout members, the contacts were very interesting and they even skipped the dinner just to be able to talk more with friends around the world.

### **Cyprus (5B4)**

participants:	850
stations:	14
internet:	0
countries:	14

"The scouts in Cyprus are very happy to take part in the JOTA", says Erricos Lanitis the National JOTA Organiser, "and requested that the scout association organises an amateur radio training next year".

Chief commissioner George Idannides sent his JOTA message "freedom and justice to our Cyprus and to the whole world". Unfortunately it was his last JOTA message as he passed away after a car accident early November.

### **Czech Republic (OK)**

participants:	165
stations:	32
internet:	0
countries:	47

The most exciting contact was made by

OK1GW in Libochovice with 9K2BI in Kuwait. The scouts in Kuwait sang scout songs in arabic and we replied with songs from the czech scout song book, writes Hana Koncicka. Funny stories came from the contact with group "Julio Correa" at ZP6ASP in Paraguay. The czech national scouts meeting on the 2 meter band on the Saturday afternoon saw a very good attendance, especially from cub scouts. An 8-year old cub scout in Bystrice has drawn the adjacent sketch at OK2PIM.



OK2PIM: JOTA as seen by an 8 year old cub scout in Bystrice.



**Denmark (OZ)**

participants:	250
stations:	67
internet:	20
countries:	11

Brian Lodahl reported: a fast look on this years reports reveals great activity, mostly as contacts around Europe. Despite the high level of sunspots these years, the conditions for radio contacts weren't good. We were happy to hear, that OY6SNP and OY6KM on Færøerne would establish JOTA stations this year. Also OX3NUK in Nuuk, Greenland was able to keep the antennas

pretty warm during the weekend despite the cold weather outside of Nuuk. The local radio amateur club and the scouts in Nuuk joined for a nice weekend.

The opening speech of this year was given by the chief Scout of DDS, John Vistesen. In his speech, John talked about the term "duty to others" as a basis for scouting all over the World. It is easy to forget to help other people in need, and also to help without getting anything in return. He said, that those, who get the greatest pleasure, are actually those, who give and not those, who are given.

In Denmark, we usually have a Ring QSO on Sunday morning. The sked peaked with 6 or 7 JOTA stations simultaneously, from almost all over the country. At one time, we also had a mobile station in the ring: OZ1FJB /J /M, who had spent the entire weekend driving around the country, working the 80m and upper bands while visiting many of the JOTA and JOTI stations.



OZ6GBE: dipoles, more dipoles and a very cold tent...

	A	B	C	D	E	F	G	H	I	J	K	L	M	N	O
1	j	a	m	b	o	r	e	e	J	r	s	c	o	u	t
2	o	m	a	a	i	e	n	i	O	a	y	o	p	n	r
3	t	a	b	i	r	c	t	e	T	d	t	m	e	d	a
4	a	t	c	u	e	e	r	r	A	i	r	m	r	r	e
5	x	e	i	n	w	i	r	e	x	o	k	u	a	r	n
6	m	u	g	p	y	v	t	h	e	s	e	n	t	s	c
7	o	R	S	T	p	e	a	s	m	t	w	i	o	t	i
8	r	S	S	T	V	r	i	f	q	g	b	c	r	a	e
9	s	f	o	X	H	u	n	t	i	n	g	a	R	n	v
10	e	r	w	k	F	l	m	v	v	h	v	t	V	d	e
11	x	e	m	b	o	r	e	p	o	r	t	i	e	i	r
12	C	Q	p	z	a	h	n	e	w	s	h	o	B	n	P
13	q	u	c	d	y	h	t	d	o	r	f	v	n	t	g
14	y	e	a	r	2	0	0	0	0	f	b	q	s	C	T
15	c	n	h	g	y	f	s	d	l	p	a	c	k	e	t
16	o	C	W	n	e	a	c	o	d	e	s	A	e	j	o
17	n	y	r	S	a	o	j	L	W	O	S	M	d	G	z
18	t	g	y	S	r	r	c	a	i	r	W	a	M	M	U
19	a	h	u	B	s	b	d	s	d	J	R	n	O	T	H
20	c	j	P	D	e	a	n	t	e	n	n	a	S	n	F
21	t	k	C	o	m	p	u	t	e	r	q	l	L	h	f

A funny situation occurred while I was in the ring, Brian says: OZ2IG with Erik at the microphone came on. Erik asked me, if my name was Brian. I confirmed. Then Erik told me, that his XYL was standing beside him, and she wanted to know if the apple pie tasted OK. First, I had no clue what so ever on what he was talking about. But then his XYL explained that she had served me apple pie in her camper on a Jamboree some ten years ago. I had totally forgotten it, but replied, that it was great.....!

As usual, the Scandinavian countries have a puzzle on air. This year, stations were given positions in a matrix key full of letters and numbers. The job was to find the correct letters in the matrix and put them in the right order to form the

d7   k12   n8   b15   b21	e13   o16   n1	h8   a2   f11	b1   j9   i13   j13   n21   q11   o2
7 2 3 4 5	6 7 8	9 10 11	12 13 14 15 16 17 18
d15   f1   e16   c14   L10	i1   a19   e21   f19   m7   g5   h12   i20	j17   k20	o14   c15   n15
19 20 21 22 23	24 25 26 27 28 29 30 31	32 33	34 35 36
L16   h2   e18	n19   j10   o7   a9	b9   L12   j21   g3   k2   h19   f4   g18   m1   j20   n10	
37 38 39	40 41 42 43	44 45 46 47 48 49 50 51 52 53 54	
j19   i2   o13   i4	L11   e19	m5   b19   i6	e2   c2   m14   o15   f17   g12   h1
55 56 57 58	59 60	61 62 63	64 65 66 67 68 69 70
k14   i21   o21   j5   n5   b5	h9   f13   j16	o4   k6   c10	
71 72 73 74 75 76	77 78 79	80 81 82	
a6   n11   d3   L21   e4   g20   i18   c19   L3			
83 84 85 86 87 88 89 90 91			

following sentence:

"Thank you for another great Jamboree On The Air. This fortysecond JOTA is the last one before the new millenium." -That is 91 letters i.e. 91 codes in all. These codes were distributed among the stations in Denmark, Norway, Finland and Sweden. It would then be possible to collect all of the codes to solve the puzzle, by only having contact within the country, but chances of getting all codes would improve, if the stations estab-

lished contact with the other countries.

JOTI is gaining more and more popularity amongst the scouts. Since most of the Danish scouts are familiar with Internet and have access to online computers, communicating with other scouts using this media is not a big step.

Scouts participated both from schools and Scout cabins using the telephone lines or network connections where it was possible. This year, a Scandinavian channel for IRC chat was formed. We would like to help everybody to combine JOTA and JOTI, in order to give scouts and guides as many good experiences as possible.

The very comprehensive danish report also contained an activity description of most stations (unfortunately in Danish), a kit building section, information on the danish scout award and a notification for the new danish radio-scouting hand-book. Well done.



### **Dominica (J7)**

participants:	5
stations:	1
internet:	1
countries:	12

Joseph Russel wrote us that his most exciting contact was with 8R1AK in Guyana. He spoke with Valda, a national trainer. They made plans to meet next year at the Carribean Scout Jamboree at the island of St. Lucia. He hopes to meet the faces of the young ladies he spoke to over the radio.

I spoke to a station in the US, says Joseph, who gave me his location as being on an estate called "Canefield". I told him that he was kidding; I work at the Canefield airport on my island. He laughed, noting that there is another Canefield hundreds of miles away in the eastern Carribean. Really amazing.

Dominica celebrated 21 years as an independent nation and as a result most of the scouts were involved in rehearsals for parades and displays. We hope for more participation next year.

For the first time we took part in the JOTI, with only 1 person, the scout leader of the St. Alphonsus scout troop. He used the nickname "Caribbean".

### **Finland (OH)**

participants:	135
stations:	45
internet:	0
countries:	27

No details in the report.



### **France (F)**

participants:	?
stations:	13
internet:	6
countries:	16

No details in the report.

### **Germany (DL)**

participants:	605
stations:	57
internet:	11
countries:	35

German Scout groups discovered a new communication-medium: the Internet! This year much more

interest for the JOTI was noticed. On the radio-side the use of the convers mode of packet-radio predominated, starts Guenter Erdmann (VCP) his JOTA report.

„HB9S – is this the chemical formula for Hablitrionium-9-Sulfat? Answer with Yes or No!“ – this was only one question of the radio-puzzle sent out by DF0CP (the VCP-HQ-station) during the DL-Sked on Saturday afternoon, where the solution was telephone number. Since we have founded this DL-sked-game, nearly all groups stay on frequency in the DL-Convers-round via Packet-Radio the whole time and listen to the other groups. The password, which was necessary for the telephone-call was given. This year, 5 seconds later the telephone was ringing!

The German amateur radio-association DARC payed for more than 2.800 envelopes and stamps, so it was possible to send a JOTA-booklet again to all scout-groups in Germany. Again we took over the Dutch idea for kitbuilding.

DL0SFS, the VCP-radio-scout-clubstation of the „Stamm Friedrich Schiller“ in Gerlingen built up a network of 8 computers. They were connected by a 76,8 kBaud quick Packet-Radio entry into the Internet. Unfortunately sometimes the network was kicked down and the scouts lost their chatpartners:

VCP-Grevenbroich and VCP-Dormagen took part on a campside. On an area of just 40m by 6m, 3 big meeting-tents (Jurten), 5 sleeping-tents (Kohten) and 2 kitchen-tents had to share their place. What wonder





that radio-antennas including a 16m high tower could also be mounted!

Because HF affected the use of the telephone during radio short-wave contacts, the members of the „Bremer Funkergilde“ put up a 30m long coax-cable for a network between their computers in the public room of the church and a server directly in front of the telephone connection. DL/PA3EFR was a Dutch/German JOTA station in Preunschen. Like previous years a lot of effort was put in the organisation. The major of Preunschen was so enthusiastic about the JOTA-station, that he offered the scouts to use the 100 meter high masts of the nearby HF station “Die deutsche Welle”. They kindly rejected the offer, as the radio amateurs couldn’t find any coax cable to connect to those antennas.... On the Saturday night a game was held, during which a message had to be transferred by semaphore, using light sticks instead of flags. A mobile packet station installed in a landrover relayed the message back to headquarters.

Lars Weimar (BdP) mentioned 7 groups of the BdP taking part.

Klaus Sperling (DPSG) mentions that the October issue of the monthly DARC magazine “CQ-DL” carried photo’s of the JOTA on its cover. The yearly reunion of scout radio amateurs took place again this year for the 4<sup>th</sup> time at the “Bodensee Treffen” in Friedrichshafen in June.



Hong Kong: ...dih-dah-dih is the letter R...

### Hong Kong (VS6)

participants:	5000
stations:	?
internet:	?
countries:	?

The International Branch of the Scout Association of Hong Kong organised the JOTA and JOTI at the Gordon Wu Hall of the Hong Kong Scout Centre as the main venue with a sub-station mainly for JOTI activity in the Hong Kong Island Regional Headquarters. Apart from local scouts, we have also invited the foreign scout groups in Hong Kong, such as Boy Scout of

America, Canadian Scouts and the Girl Guides of Hong Kong to take part in the event.

With the help of scout leaders, scouts were able to operate the wireless transceivers to communicate with local and overseas scouts through the temporary radio station set up in our Association Headquarters. Participants were also taught how to use simple equipment to perform different ways of communication like Morse Codes, Standard Phonetic Alphabet as well as communicating through wire and cords.

An exhibition on the introduction of Internet in scouting was displayed in the main activity site. This year, we have designed a special game in our home page and encourage scouts to participate in the game through Internet. According to our record, there were about a thousand visitors visiting our homepage in those two days.

Our experience tells us that the majority of the participants were cub scouts, we have therefore designed some games suitable to their age group relating to communications, such as decoding of Morse codes and the semaphore signaling.



.... He, listen, I just won the morse code competition....

A booth for silk screening was also set up for participants who wanted to have a logo of JOTA/JOTI of this year painted on their T shirts as souvenir.

### Hungary (HA)

participants:	6
stations:	3
internet:	0
countries:	23

Tibor Végh writes us that he got 3 more stations for this event. At one of them, HA5MCK operated by the grandmother of the two scouts Ati and R. Two stations managed to contact HB9S. Tibor is very interested with the interest of the scouts; he visited all stations and will use



### India (VU2)

participants:	3600
stations:	10
internet:	4
countries:	16

Dr Kumar reports that the most exciting contact they made from VU2BSG was with Jeff at VK6SCH in Australia and Kamis at A47JOTA in Oman. Quite an exciting experience for the scouts to hear and respond to the friends in other parts of the world.

Mrs. Prasad explained about the services offered by amateur radio stations during natural calamities like cyclones, floods and earthquakes.

Scouts presented themselves and their schools over the air by giving some personal details and telling about scout activities. The guides had a different story. Their songs were appreciated and enjoyed by their fellow friends on the other side of the world.

Via internet they received the speech of the Chief Commissioner of Australia, William Wells and of the Governor General, Sir William Deane. More international contacts could be made on internet.

A quiz, drawing and painting, sing a song and electronic kit preparation were amongst the side activities.

### Ireland (EI)

participants:	?
stations:	?
internet:	?
countries:	?

Sean O'Suilleabhain from the 132nd (Bayside) Dublin Unit mentioned that his station EI4BST took part with approx. 50 Scouts, most of who spoke on air. The packet BBS and DX cluster also attracted a lot of attention. The station had only one contact on HF with EI,

a local station within 2 miles of the Scout Den.

The best contact worked over the weekend was ZS1QUN although it was not a Jamboree station. One of the Scouts, Killian Costigan, from the Unit's Tuesday night Scout troop worked the station after calling CQ Jamboree for approx. 10 minutes. However it required a lot of effort on his part to confirm the two way QSO on account of difficult conditions and QSB.

### Japan (JA)

participants:	621
stations:	63
internet:	21
countries:	12

Toichiro Nishiyama writes us that the most interesting contact of the weekend was with VK4SCC, Ajen and 30 scouts. This QSO was made on 21.357MHz. Their signal was very strong, and we exchanged the information on the weekend and Scouting activities. Ajen passed the microphone to their Scouts to say "Hello" and introduce themselves to us.

Nippon Boy Scout Amateur Radio Club (JALYSS) operated their station at National Headquarters of the Boy Scouts of Nippon.

Some stations tried to communicate by internet. The Boy Scouts

of Nippon provided a guest-book on our WWW page for JOTA / JOTI communications and more than 100 scouts and leaders wrote messages in the quest-book.

It was reported this year again that many portable stations were operated during the JOTA such as in mountains, at banks of rivers, at Scout halls and at outdoor activity centres.

The amateur radio club of Aichi Scout Council, JH2YSS, set up their station at their Yoshikawa scout camp with 10 operators.

Before the JOTA, the Boy Scouts of Nippon circulated the information to scouts and leaders on the 42nd JOTA through our local Scout Councils, Scouting magazines and JARL News.

The club members of the HO station, JAIYSS, had a meeting and shared information on the JOTA during the JARL Ham Fair in August. They also had a

preparatory meeting for JOTA at the BSN National Headquarters and set up their new 4-elements Yagi Antenna in September.





### Kuwait (9K)

participants:	40
stations:	1
internet:	1
countries:	?

The 42nd Jamboree on the Air was arranged by the Association in cooperation with the Kuwait Amateur Radio Society and the Kuwait Science Club.

The camp began with a pre-meeting was held on Monday 11 October 1999 with all the participants to show them the program of the camp, and during that time Mr. Fawzi Mahmoud Fargali, the General Secretary of the Arabic Scout Region, was in visit to Kuwait and attended the meeting with all the scouts and the supervising committee and he thanked them for that achievement

Participants were the Scouts of Kuwait Boy Scout Association, Kuwait University Rovers, Kuwait Science Club, General Department for Private Education.

All of the participants were exchanging talks on the air through amateur radio and internet and at the same time the Kuwait Science Club participated only through the internet. The scouts and rovers were separated into four groups exchanging the participation between them with the internet and amateur radio.

During the break period, a competition was held for the participants about how to design the 43 JOTA-logo for the year 2000, and three prizes were presented for the three first winners.

I think that this Jamboree has achieved its targets which were put for it, and the participation was very high from all over the world and was positive, concludes Camp Supervisor Abdullah Ibrahim Al-Bloushi.



### Madagascar (5R8)

participants:	70
stations:	3
internet:	0
countries:	15

Ranarisaona Raymond reported activities like sports, stage plays, language shops, world-wide scouting exposition, scout games, official ceremonies and a camp fire.

The Ministry of Youth and Sports wrote a special recommendation letter for the JOTA / I.

### Malaysia (9M)

participants:	8000
stations:	?
internet:	?
countries:	14

Once again Malaysian Scouts and Guides joined the rest of the world in the 42nd Jamboree On The Air. Scouts and guides showed they were already in the information superhighway. It was the best, the biggest ever. They managed to contact scouts and guides from around the world through the amateur radio and the Internet.

Participants in some stations were assisted by members of the Malaysian Amateur Radio Transmitters Society who tirelessly and patiently taught the participants how to operate and speak through the ham radio. Another station even got a mobile Internet **unit** provided by MMOS, one of the ISP in Malaysia. The bus was equipped with 10 workstations, a server, a hub, an uninterruptible power supply unit, a modem, a generator, a digital handset, a digital camera and printer, writes Wang Nyap Tang.

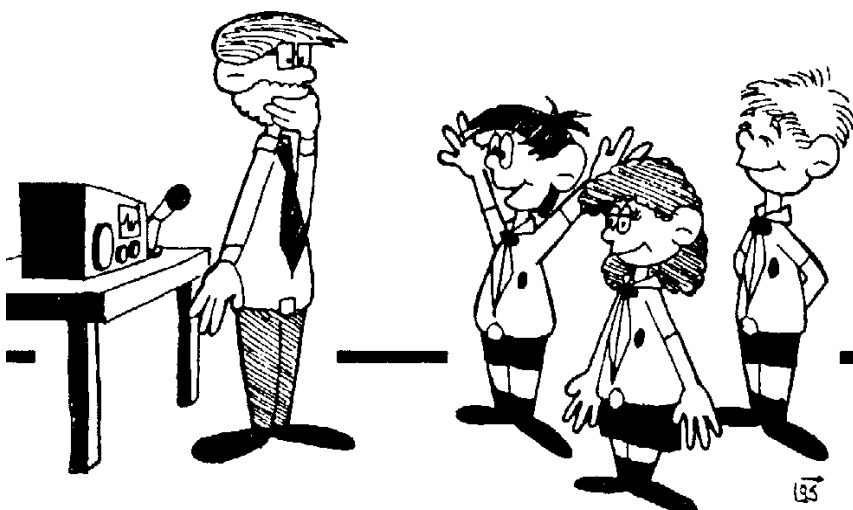

### Morocco (CN)

participants:	12
stations:	1
internet:	1
countries:	5

The scouts had set up a radio station at the

National Scout Centre Abdelkrim el Fellous, some 11 km from Rabat, and obtained the special call sign CN42SM.

Adil Freidji reports that they had a nice contact with 7X2JOTA in Algiers and exchanged information with scouts that took part in the "three-cultures" meeting in Spain.

One radio amateur heard some chickens made noise; he jumped up because he believed he had a radio contact.

**Mozambique (C9)**

participants:	55
stations:	0
internet:	5
countries:	38

Silvio José mentioned that the most popular web site was [www.pages.whowhere.com/community/scoutsmoz](http://www.pages.whowhere.com/community/scoutsmoz), but no further details.



**Netherlands Antilles (PJ)**

participants:	70
stations:	1
internet:	0
countries:	19

We had a very good conversation with scouts in Trinidad who had their camp in Curacao last

sum mer. It was exciting because the scouts from Trinidad could tell our scouts a lot about places in Curacao, writes Hubert Martha. The Trinidad scouts held an on-air competition with our scouts in scout yells. When the Trinidad scouts had no more yells, they gave a yell in papiamento (our native language) which they learnt during their stay here.



*...mijn naam is Antoine en ik woon op Curacao....*

Once again the station was set up at the university. We had a record number of scouts participating. It was a very good camp with JOTA / I, lectures sports and film.

**Netherlands (PA)**

participants:	25300
stations:	271
internet:	100
countries:	52

The internet quickly integrated into the JOTA over the last years in the Netherlands, says NJO Jan Kluiver. After an enormous growth in the previous years the use of internet stabilized at around 64% of the participating JOTA-stations. JOTA and JOTI can complement each other nicely. Hans Sliker, PA2CJS, operator at PA6JAM/J was seen enthusiastically in front of a webcam, with the HF microphone in his hands: "Do you see the colour of the uniform I am wearing". For those radio amateurism minded people who are concerned that internet will take over from the radio waves: we heard the first stories from scouts and guides that found the internet nothing special and moved to the radio set.

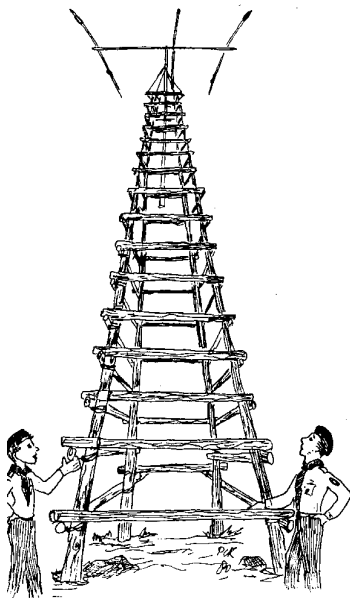

The dutch JOTA-organisation will stimulate the use of Amateur Television: a new challenge for both scouts and guides as well as the radio amateurs. This year 19 percent of the JOTA stations had ATV. In the densely populated Netherlands with many ATV repeaters this is a promising start of a new dimension to JOTA.

The world JOTA/JOTI game was played by 12% of the dutch JOTA-stations. Most groups had problems to come in contact with HB9S for the necessary information. One group succeeded: PA3ELQ/J, a combined station of the air scouts of the Anthony Fokker group and Scouting Hoogeveen.

Specially for JOTA a lot of towers are built by the scouts and guides. The Rover Crofts group (PA0ARE/J) are specialised in these constructions, with a height of 50 meters. This year hooligans demolished weeks of work from the Scouting group De Brimzen in the north of the Netherlands (PA3FBB/J), just 2 days before the start of JOTA.

At PA0GEA/J in Utrecht a number of soldiers turned up for a game. They carried a lot of gear, just to make a telephone call to a phone set a few meters away. To do this, the signal had to travel four times 36.000 km and suffered from several seconds delay.

PA0JNH/J in Zaanstreek took part in the JOTA cross: a programme organised by scouts, during which unbelievably difficult questions, fabricated by "clever" people, have to be answered and the answers have to be send in



code. As always, results obtained in the past give no guarantees for the future: they ended 10<sup>th</sup> place instead of 3<sup>rd</sup> as last year.

Eindhoven saw a fierce battle against millennium bandites and virusses, using computers and radio communications by the scouts of PA0OSS/J.

PA3BUL/J in Voerendaal was set up on an old pile of coal of a former colliery, whilst PA3CWN/J in Dokkum had a free internet access via the local TV cable system; it only took a cable technician a whole morning to install it.... In Brunssum PA3FZU/J used a telescopic 34 meter high mast of AFCENT. Setting up this mast was an exercise for an international group of military.

Scouting Zevenbergen was a bit worried that it didn't rain before the JOTA: the rain would have tightened the lashings on their antenna tower for PA3DEW/J. But all went well. They were even capable of transmitting messages with a 3 W light bulb over a distance of 89 meter.

The St Willibrordus group invited the St Tarcisius group to participate in the JOTA. The disabled scouts and guides spent 2.5 hours in all kind of activities, including communication games and radio communication in the station PA3GUN/J.

### New Zealand (ZL)

participants:	2000
stations:	36
internet:	0
countries:	9

JOTA in New Zealand this year did not have as many taking part as in previous years mainly because of an extremely limited budget for promoting the event. The main promotional medium used was the New Zealand Scout Web Page as there was no other way of getting information

to Scout and Guide units. Better luck next year. Although I shall again have a zero budget, says NJO Jim Parnell: the reason for the zero budget is that the NZ Scout Association lost heavily on its last Jamboree - the one which I contacted several times from the World Jamboree at Picarquín, Chile. Consequently, they couldn't let me do anything which would cost them money, and that included copying and postage.

Even so, there are many Scout and Guide units who know the value of JOTA and take part year after year. They were active again this year and had a most enjoyable time. I managed to get to the camp site of the local JOTA station, ZL1ROT. The bands were very quiet by then. However I was able to make a contact with a station in Uruguay.

The number of scouts fell again this past year - it has been falling for years and no one has been able to find the magic formula to stop the drop. I blame in part, the total change in NZ society over the past 10 years or so from a welfare state to one where it is every person for themselves. People are so busy trying to keep their jobs that they have no time for voluntary work such as running scouts.

The adventure game of John Bont was a non-starter in this country as it was not possible to get the numbers from HB9S needed to start it. Should a similar game be run again, it would be a good idea to provide the number to stations elsewhere in the world (perhaps to selected NJOs so that they can give it to those playing the game in their area.

### Norway (LA)

participants:	960
stations:	42
internet:	8
countries:	34

Dag Anders writes: the Norwegian Jota was held in a traditional manner, the only alteration was the number of stations with JOTI. These stations are often connected to a radio station, but we expect there are large numbers of unregistered users (groups etc.), which also participate. The spontaneity on the internet may be one of the reasons for this, the original model of organisation is too slow.

The Norwegian main station LA1JAM was situated at a school at Lena. At this station, there were scouts present from 7 scouting groups from the constituency of Vestoppland. These groups were: 1. Biri, 1. Vardal, 1. Hov, Gjøvik sentrum 5. Gjøvik 1. Kolbu og Hoff. The total number of participants was between 60 and 70. This year, the main station had both radio and internet activity.

This year's Nordic puzzle was made by the Danish JOTA committee. Several groups participated in the international game which was held in connection with JOTA and JOTI; we see it as bridge between JOTA and JOTI. JOTA is about to change into something more than an event regarding radio only.



PA3ALJ: high above sea level..



## Oman (A4)

participants:	135
stations:	1
internet:	1
countries:	44

All contingents from rovers, scouts, girl-guides, cub-scouts and brownies were QRV to take part in the event, says Dawood Al-Zidjali. We began the transmissions on the early Saturday morning. Prior training in theory and practice was given to all and this resulted in an excellent turn up of participants. Most of our contacts were with JOTA stations in which we exchanged songs and greetings. Scouts were excited by a contact with their tunesian counterparts for the first time. I also had a contact with the president of the Arab Regional Committee, writes Dawood.

We were also active on internet and made many contacts with other scouts and girl-guides. The event was covered by daily newspapers, radio and TV. Amateur radio badges and certificates were presented to all participants at the end of the event.



... CQ Jamboree, CQ Jamboree. This is Oman calling...

## Panama (HP)

participants:	350
stations:	10
internet:	8
countries:	7

Eric Macias says that each time his radio amateurs wanted to leave the frequency for some else, a new contact was made and they couldn't leave. He suggest to plan radio activities in a year that the solar activity does not affect the communications so much. They had to make contacts very quickly and some information was lost because sometimes the contact would drop out.

## Poland (SP)

participants:	230
stations:	20
internet:	0
countries:	34

On the 16<sup>th</sup> of October we had a beautiful contact with Eugeniusz, F5LWV. He was a member of polish scouting from 1936 till 1939 and could tell a lot about the history of ZHP, writes Jan Ladno. Another surprise was the contact with GB4YOU. When I mentioned that my call sign is SP5XM I hear an XYL voice asking "hello Jan, do you remember me? I am Lynn and we met in Paris at the radio seminar in 1997".

This year the HQ station SP5ZHP was located in Jarocin using an impressive antenna park and high power output. The scout club station SP3ZHW gave out a special award on the occasion of the 42<sup>nd</sup> JOTA: if a station made 42 contacts with a distance of 42 km on 144 MHz, it could get the award. The oldest newspaper in the region of scout club SP2ZCI wrote a special article about JOTA.

The millennium adventure of John Bont was a very nice game, Jan concludes.

## Portugal (CT)

participants:	10490
stations:	15
internet:	6
countries:	51

Celestino Martins (AEP) commences his report with:" in the period where the communication between people becomes the most important thing to

solve the world problems, the scouts meet together once more, to create an amateur radio station and / or a computer, in order to encourage friendship between youngers, to construct a better world, as it were required in the last messages of the founder, Robert Baden Powell".

The preparation for the participation of the Portugal Scouts was supported by informative packages, sent to their groups with directives and suggestions before, during and after, and by our web page.

There were installed five regional radio / internet stations spread over Portugal including the portuguese islands Azores and Madeira.

We must say that was a great involvement by all participants and for the fact that most of the radio stations had



Woow, look at this list of scout web pages.....!



already radio-amateur scouts.

Most exciting contacts were from CT7GEI in Lisbon with HB9S and an exchange that CT7EPE had with youngsters in the Netherlands. We had a JOTI video conference with australian scouts. Great to see them and their shack in a typical australian farm. We send them images of the interior of our headquarter station.



CT7ELP: hurry up, I can'thold this any longer...!

Site activities were a.o. morse code, sports, music and camp fire. A special patrol daybook was made for each participating scout, with space to write down the contacts he made and a little history of the JOTA.

The youngest radio amateur in Portugal is a 17 year old boy scout of group 6 in Olhao. José Augusto Marques Joaquim (CNE) writes us the following: this 42nd Jamboree on the air and on the internet was a great opportunity for many new scout troops to take part in this big scout event. It was also a very good opportunity to celebrate Children's Rights Convention's 10th Anniversary, which was the principal subject onboard all the stations participating.

This year for the first time we had stations operating only via Internet, witch is becoming the most wanted mean of communication in the JOTA. For this purpose we made a special site in the Internet containing many activities for the JOTI participants like, forum discussion groups about JOTA, JOTI and Children's Rights, netpaper, netmeeting and, of course, a chat channel.

The national station of C.N.E. had his QTH in Lisbon, right in the National Scout Center, near Tejo River, downtown Lisbon. We created a special theme to be the base of all the activities of JOTA and JOTI. It is more easy to have a common ground so every body could be in the same "frequency" and talk about the

same subject. It was a surprise for us, because all the scout troops took the subject very enthusiastically. The national station of C.N.E. was operating from the National Scout Centre, in Portugal, with the support of the Technology and Scientific Ministry, who borrowed us a special truck fully equipped with 12 computer terminal connect to the Internet Portuguese JOTI Home Page. It will be the permanent CT1CNE station. We are making an effort to maintain this station operating all year, to develop radioscouting activities.

In the opening message our National Scouts Coordinator spoke about the ways to find in our conscience the Children's Rights all over the world and about the commitment to spread them in the community. He also mentioned that we must follow our scout law in our every day life. Timor-Lorosae was also mentioned, spe-

cially the Children that suffers, and our scout friends in Timor. Timor Lorosae was suffering and the Human Rights were forgotten there. Many of our scout groups organized several activities to remember Timor, like cooking contests, discussion forums and songs contests.

The Nucleo de Moinhos de Ventos has operated his station were the EXPO 98 Ecological Centre. They held fauna and flora observations, and they have been recovering the area.



CT1CNE: children's rights discussion.

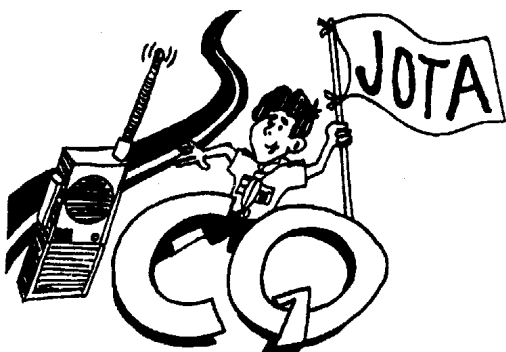

cially the Children that suffers, and our scout friends in Timor. Timor Lorosae was suffering and the Human Rights were forgotten there. Many of our scout groups organized several activities to remember Timor, like cooking contests, discussion forums and songs contests.

The Nucleo de Moinhos de Ventos has operated his station were the EXPO 98 Ecological Centre. They held fauna and flora observations, and they have been recovering the area.

We will be holding radio meetings every month, in VHF and HF from now on every last Thursday of every month.

### Romania (YO)

participants:	170
stations:	7
internet:	6
countries:	29

Niculae Draguleanu wrote that the standard JOTA concept, in which the scouts speak to one another via radio attracts a lot of interest

from the scouts.

### Senegal (6W)

participants:	110
stations:	1
internet:	0
countries:	31

The scouts in Senegal were proud to contact

HB9S, the station of the World Scout Bureau, which allowed the campers on our side to exchange ideas with the world JOTA organizer, writes Mamadou Daffe. Our Scout Association is looking for partners to help us improve our radio communication system that we use to support large scout gatherings.

### Slovakia (OM)

participants:	101
stations:	7
internet:	2
countries:	26

Josef Bojanovsky reports the following. In our Trencin Scout region, we have had only one radio station OM3OF operated by

Ado Sedlacek in Nove Mesto nad Vahom. Little did we know then that Ado would pass away on 17 November. For 9 years we worked together for radio scouting. We will not forget him. Young Scouts were trained there during the whole year in the field of radio-communication.

An interesting thing happened on the first day of JOTA. Operator Ado had the radio station prepared in our club-room. When Scouts came, we stretched out a 40 meter long antenna from the building to the nearest tree. We tried several connections when a strong wind blew and the branch on which we had fixed the antenna broke and fell down. Connections were down, too. Ado linked the input plug of the antenna to the pipes of central heating and started broadcasting CW-morse. How big our surprise, when we found out that not only the repair worked but we even received messages from the Netherlands and other distant countries, including the radio station of the World Scout Bureau in Geneva HB9S! That made us really happy!

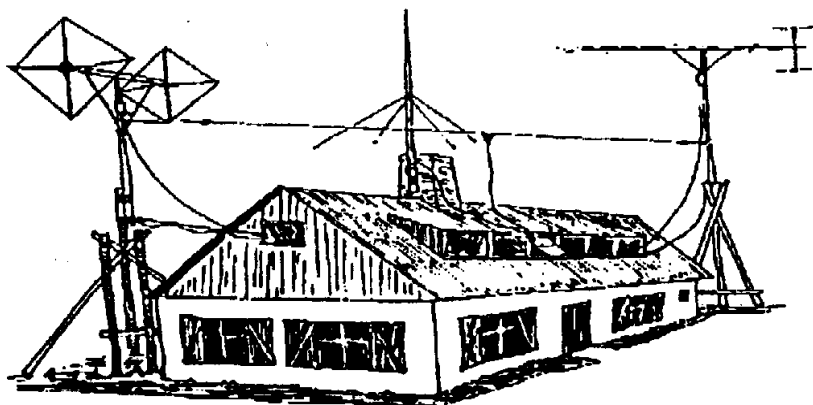

during the JOTA was made with operator Khamis, radio station A47JAM from the United Arab Emirates.

### Slovenia (S5)

participants:	55
stations:	2
internet:	8
countries:	23

It seems that computers and internet are more popular to younger scouts than talking on the radio. In the future we will try to put together JOTI and JOTA, says Promoz Bajec in his report.

Slovenian scouts operated with two radio stations S59ABC and S59ZTS. From Sleme in the NE part of Slovenia S59ABC was active. All kids this year had really a good time. The QSO with JF2EPL and its operator Kam from Nagoya was the longest QSO that this radio station did during JOTA weekend.



Thanks to better conditions on Sunday, we could broadcast from the recreation area "Zelena voda" (Green Water) near the town Nove Mesto nad Vahom, using the reflex effect of the lake's large water surface.

One mobile radio station OM3WAD operated by Vasil was on the air from the hill of Velka Javorina (970 m) in the Biele Karpaty mountain group, the border point between Slovakia and the Czech Republic, together with Czech radio station OK2BTZ. The most interesting contact



They were not radio-active all the time so during spare time some participants were involved in scouts games, others were making some sculptures from pumpkins.

The second radio station S59ZTS was located near Cerknica, a small town about 40 kilometers south from capital city Ljubljana. S59ZTS was the HQ of Slovenian scouts. The QTH was far from being excellent (almost a broken antenna and rotator, QTH located in the valley) our signals mostly stayed in Europe. After I solved the problems my JOTA weekend really started. I'm not superstitious, Primoz Bajec writes, but it seems that the QSO with WOSM HQ (HB9S) brought me luck because almost all my troubles disappeared.

My wish was to do some QSO's also with scouts stations from other continents but very soon I realized that I became a "hot" radio station for a lot of participants. Many operators said that it was their first contact with any slovenian radio station !?

Some words about four QSO that were, in my opinion, the most exciting:

- Hielke, PA3BLG wasn't a scout but he helped during the Jamboree in Holland a few years ago. He is not an ordinary radio amateur – he is blind, so he told me how he uses a special computer for blind people with Braille writing.
- John, who worked under call sign LA6RHA had around him young scout Ingrid, Camilla, Ranveig and Catrine. They were a little bit nervous during our QSO but girls I must tell you once again – you did a great job.
- GB0TWS and operator Peter was the biggest surprise for me. He knows Slovenia very good because he spent some time here. Hopefully we will meet during his next visit.
- Steven, GB2CDS and young scouts Ewen, Daniel, Alex and another Daniel finished my 42<sup>nd</sup> on a most pleasant way.

A few words about John Bont game – the idea was very good and the first time JOTA and JOTI teams worked together. Hopefully there will be more of that kind of games in the future which will help all NJO's to bring more new scout groups to participate on the air or on the internet.

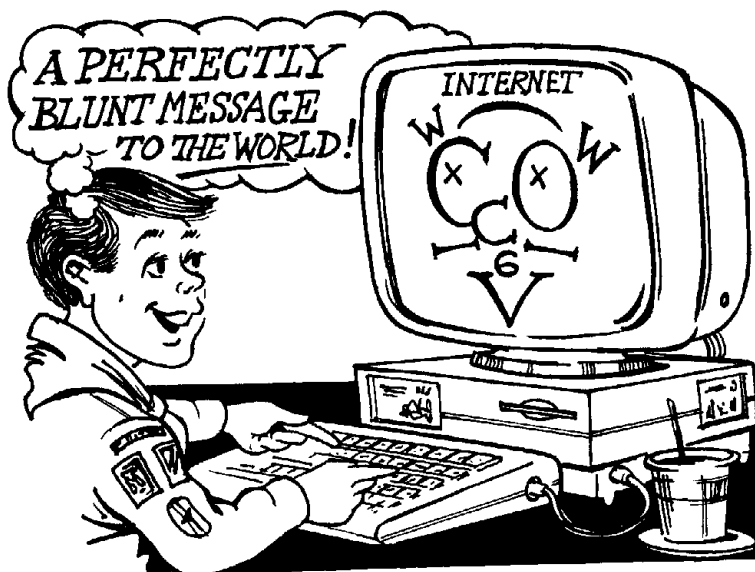

### South Africa (ZS)

participants:	2460
stations:	20
internet:	2
countries:	6

NJO Dave Gemell writes us the following:

Ozzie Carstens ZS1DZ has called it "the Jinxed JOTA". It started off by the usual Cape Town camping site on Signal Hill being booked for some other activity on JOTA week end! So he combined with Buddy ZS1MP at Zandvlei Sea Scout Base, on the False Bay coast, to run

ZS1SEA. After a bit of wind trouble, (which was gale force by Saturday morning) the new antennas were erected. A sea scout regata had been organised but the second leg on the Saturday afternoon had to be cancelled due to the



ZS6MUS: watching the birdie....which one?

ZS4BOY for the Dagbreek Scout group. Every Guide, Scout, Brownie, or Cub who spoke on the air received a certificate made by the radio club. The station was visited by the Chief Scout of South Africa who transmitted his annual JOTA message.

very high winds. Thus at about 14H00 the JOTA station was "invaded" by many of the Scouts. No sooner had the sea scouts arrived, severe electrical interference threatened to prevent further radio contacts.

It took Buddy and Andrew just under an hour, after driving around the area using a portable Ham rig, to discover that this interference was a loose connection in the wall plug in a nearby boat house where the sea scouts had plugged in a kettle to brew a quick "cuppa".

The members of the Welkom amateur radio club manned JOTA station

The Dagbreek station also had an Internet link but not all the youngster could pass messages. One Brownie commented " I do not know who I am talking to....."

Thanks to Willie ZS5WI the 1st Eshowe cubs were again able to take part in JOTA 1999. Willie says that the cubs found morse code great fun and called his practice oscillator the morse code machine! Not many contacts were made as the Cubs would rather chat on the radio with their counterparts in other parts of the country.



Another high light was when they listened to the Chief Scout of South Africa's message transmitted from ZS4BOY in Welkom in the Free State.

Pietermaritzburg guide JOTA station ZS5PMB was on the air again operating from the guide camp World's View, a very high point just outside the City.

ZS6MUS was run from the radio room of the "Friends of the South African Air Force Museum" at Swartkop Air Force Base, just south of Pretoria. The ZS6MUS clubhouse was about 100 metres from the main runway at Swartkop and a few light aircraft took off on training flights so there was definitely an "aircraft atmosphere".

We were just about to close the station down at about 17H00 when Dave ZS6AAW made contact with Bill VK5SZ of the 1st Kalgoorlie Scout Group in Western Australia. This was an exciting moment.

One of the local cub packs, 37th Springvale were unable to attend the large JOTA/JOTI event in Johannesburg so they asked Ray Webber ZS6RSW to run their station ZS37SS from their hall.

Ray also collected enough components to make several crystal sets which were a big success with the cubs. And tis is what cub scout Jason Webber had to say about the event:

*"October 16th & 17th was JOTA at 37<sup>th</sup> Springvale Scout & Cub group. Everyone was very excited. About 7 Scouts, my dad and I slept over on Friday night at the hall. At midnight we started up the radios. Our call sign was ZS37SS. In the morning we all got up early and my dad let us talk on the radio. At 8 o'clock, about 20 Cubs arrived at the hall. We had great fun on the jumping castle, which Bagheera brought, until 9-o'clock when we made crystal sets, buzzers and electro-magnets.*

*At 12 o'clock another 10 Cubs arrived at the hall, and they too made crystal sets, buzzers and electro-magnets.*

*At about 5 o'clock was time for the electro-magnet crane competition. We all built cranes and each one tried to pick up the most. Mark Dalancy won and he got a 71-in-1 electronic set. 6 o'clock was time for the bring & braai at the campfire. After the braai we talked on the radios and then went to bed. In the morning we talked a bit more on the radios. At 8 o'clock, 7 Cubs came and they too made crystal sets, buzzers & electro-magnets. We closed off at 12 after a great JOTA weekend....."*

There was a very large JOTA/JOTI station held at Gilwell, the training camp site for the Witwatersrand Scout at Florida Lake.

The Rosebank Scout hall had another large JOTA/JOTI station in action. The actual JOTI station was across the road at a friendly computer firm in the local shopping mall.

The 1st White River group seems to have more luck with international contacts than some other SA stations! The most interesting contact was with Freek at PA3ENE in Holland.

This was sheer chance as the White River Scouts did not know that it was Freek until he mentioned the work with them. The two Groups are working in partnership with one another.

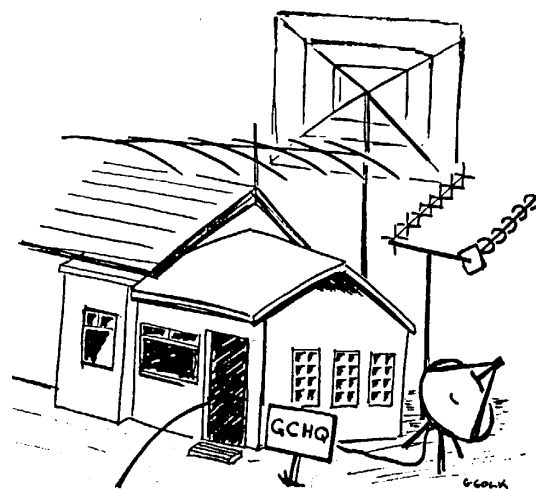

## Spain (EA)

participants:  
stations:  
internet:  
countries:

The scout group in Aragon took part in *No, no, this is Gilwell Communication Headquarters!* the JOTA and made 225 contacts with their station ED2SDA. The local guide

group joined them in the event. They had a lot to do in answering the packet messages that had all come in as a reaction to what they had sent before the weekend.

The grupo Severo Montalvo in Aguilas was on the air again with ED5SSM. Their station was set up at the location of the radio club, which houses in an old water tower. The first contacts on the Friday evening were with scouts on the Canary Islands. Many others with spanish-speaking countries followed. They enjoyed a contact with 5 stations at the same time and with the World Scout Bureau in Geneva.

The group invited other scout groups to join them, among others the groups "El Carmen", "Almenara", " Renfe", "Boscos" and " Kiro". Together they had a brotherhood meal on the beach.

# RADIO ROVERS

This year they again set up a station on the beach, because it is an adequate place to accommodate the whole group and it is suited for the technical installations.

Their most exciting contact was with Mamadou, 6V1S, in Senegal. Scout leaders Desi and Antonio spoke in french with Mamadou and Bill and told them about the summer camp that we had organised together with scouts from Great Britain and France. They spoke about the daily activities, the organisation and working methods. We knew that members of FCEG had a co-operation programme with Senegal, around Dakar. We listen to a short summary of senegalese scouts that had worked in Spain. We exchanged tele-fax numbers and email addresses.

Scouts form Taby in Sweden gave us a life description of the first snowfall of the autumn that was falling on them.

Speaking with scouts in other places on the globe is an amazing activity and all our group members, from cub scouts to explorers, took part in it; boys and girls from 8 to 21 years of age, scout leaders and scout's fathers. The direct contact, from boy to boy, offers an important personal enrichment. In addition, addresses were exchanged for future contacts by mail and participation in other international exchanges with other countries.

## Sri Lanka (4S7)

participants:	?
stations:	?
internet:	?
countries:	?

We discussed about scout activities in general and the number of scouts taking part in the JOTA, writes K.H. Camillius Fernando.

## Switzerland (HB9)

participants:	100
stations:	9
internet:	0
countries:	19

Participation was low due to the holidays, writes Jürg Hebeisen.

HB9JAM in Kirchberg had a foxhunt on the Saturday afternoon. In 3 groups they are looking for the fox. Amazing how well this thing can be hidden....! The whole thing is more like a compass course. After all, the fox transmitter is not switched on until 30 minutes after the start of the course. If you don't know where you are by then, you can just follow the bleeps in your receiver and get to the target almost automatically.

The internet set up was divided over two scout huts, with an 80 m cable in between them. While chatting, the scouts met the party in the other scout hut on-line, but often didn't realize that because of the nicknames they used. HB9CUP in Emmental had set up their station in an alpine meadow, with cows and goats. The guy wires of the antenna mast were especially attractive to the goats....

HB9KOM set up the station in a tent near Winzenberg and needed a 200 m long power cable and a telephone line of equal length to connect to the outside world. With 3 PC's and a network in between them they set up a small internet café (but without eal coffee as there was no coffee machine....). The sked with a group of rover scouts in New Zealand didn't work out unfortunately.

The scouts in Seedorf at HBCF were invited by radio for a party by Scouting Ridderkerk (Netherlands). They forgot that there is a days-drive in between them. The Seedorf scouts did consider a quick visit... But they enjoyed their own famous swiss chees fon-due.

## Tanzania (5H)

participants:	0
stations:	0
internet:	0
countries:	0

Osmund Kipengele informed us that there was no JOTA participation due to the sudden death of Julius Nyerere in the same weekend.



## Thailand (HS)

participants:	754
stations:	12
internet:	1
countries:	10

The special call sign HS0AJ was licensed to the National Scout Organization of Thailand for the 42nd JOTA. HS0Ax represents a club station and J was for Jamboree. The station was set up in the National Scout Organization of Thailand area in the National Stadium. There were HF, VHF, Packet radio and Internet.

On 11 October, Dr. Jacques Moreillon, the WOSM Secretary General paid a visit and officially presided over the opening ceremony of HS0AJ.

On 16 October Mr. Suwan Kusujarit, Director General of the Physical Education Department sent a message to the scouts through the HS0AJ station. There were about 55 scouts present.

Thailand is one of the countries where the communication laws do not give much chance for the children to get in touch with radio. This is the second year that the scouts were officially permitted to get on the band for the JOTA programme, writes Dr. Sasithara Pichaichannarong.

## Turkey (TA)

participants:	?
stations:	?
internet:	?
countries:	7

Savas Baran writes us: this year our scouts participated to JOTA and JOTI under difficult circum-

stances after we had two earthquakes. We begin to work after we received the 41st JOTA report and we learned the design of Turkish Guide Dilek Avci was selected for the participant card for the 42nd JOTA. A long list of suggestions for summer activities was distributed to scouts and guides. July was the time for camps at some region of Turkey where we

tried our best to introduce the JOTA and JOTI. We have a book of 73 JOTA/JOTI activities.

Second half of August a quarter of Northwest Turkey was shaken by an earthquake. All radio amateurs and scout radio amateurs were officially called to work in crises coordination centers in cities.

All scout activities concentrated on relief work and it is still going on. These activities and involvement prevented us to join to JOTA in full.

We made a couple of projects on the internet, one of them named secret service, and this project is still alive.

After the JOTA we began to make internet workshops in internet cafes around to Turkey with simple games on internet. The first one was at Bolu Turkey where some 15 scouts and guides participated. They get e-mail addresses from hotmail or yahoo.

All of the scouts and guides are Turkey still involved to help disaster areas to implement wonderful relief projects. But the most importing thing which we found out is that we must work better to train young scouts radio amateurs and prepare them for such situations.

## United Kingdom (G)

participants:	1960
stations:	173
internet:	0
countries:	50

Les Mitchell, the JOTA founder, sent in his personal log of the event. Les made quite a few contacts on 80 m and 20 m. His comments on the "ones that got away": "I heard VK6SK working a VK5. I could not hear the VK5 at all. The VK6 must have been passing south of ZL on a great circle north up the atlantic following a line parallel to the coast of South America to reach the UK, over 18.000 miles. There were scouts on the mike at both ends of this contact in a rapid fire conversation: "my hobbies are swimming and basketball. What are yours? over." I tried to break in with no luck. I am sure the scout concerned would have been amazed to hear that his conversation was being overheard in the UK."

The UK Scout Association provided us with the participation numbers.

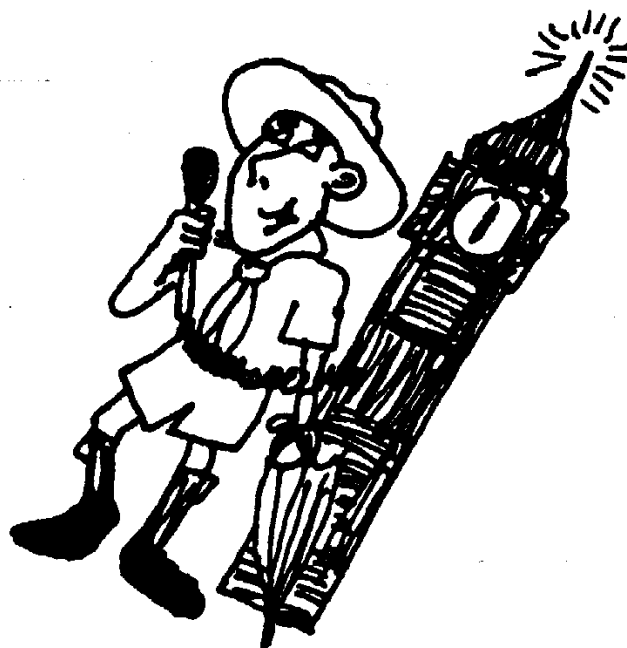
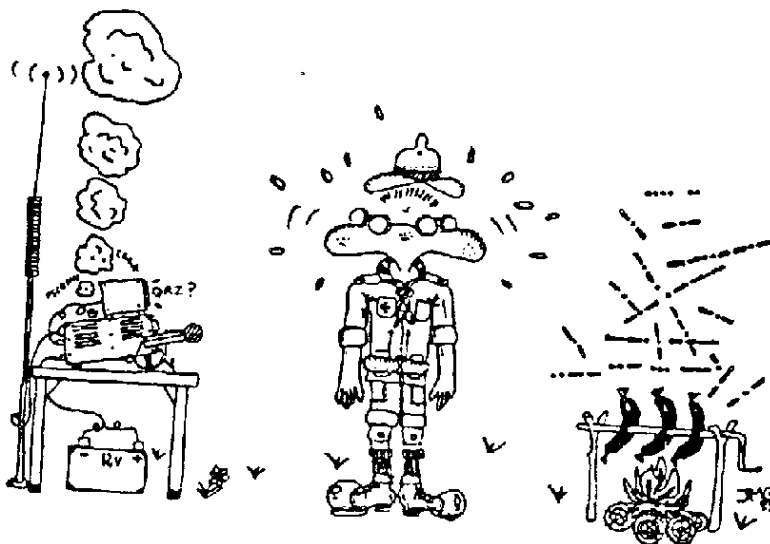



**United States (W, K, N)**

participants:	11880
stations:	1775
internet:	0
countries:	?

JOTA 99 was a large success. Scouts, scouters and amateurs got together and put on one of the best events in recent years. The following interesting contacts, and funny situations are just a few of the many great stories shared this year.

One station had a ham shack of 4 x 6 foot but when a contact was made with DF0RW there were 8 scouts plus 6 leaders and 3 amateurs all trying to get close to the radio.

An eight year old cub scout was interested in getting his amateur license and even his extra class license but when asked if he was interested in girls he responded with HECK NO!

Another JOTA station was run at a camp where the Order-of-the-Arrow fall ordeal was being held and when the scouts were asked if anyone had anything to say no one would speak. The scouts were all taking their OA ordeal during which they aren't allowed to speak.....

And finally a young scout from Virginia asked an English boy scout in England if he spoke English. The scout replied "we invented it".

Scout Troop 38 hiked 10 miles along the Appalachian Trail and setup the radio equipment to operate during JOTA. A group of cub scouts



WB2CIK: "...a small shack with many scouts all trying to get at the radio...."

from Pack 34 in Huntington New York thought they were talking to aliens since it was the first time they had ever heard so many different accents at one time. Fox hunting was done by Crew 1085 and other in Cedar Rapids Iowa. The scouts found out by asking that there were only two places colder than Cedar Rapids. The mountains of Nevada and Siberia. A contact from Bradley Lowry's grandfather who was in Daytona Beach Florida during hurricane Irene. He was OK. An earthquake hit the camp area at 2:44 am but most of the scouts did not wake up. The next morning they had a real story to tell on the radio.

Fox hunts were big this year. To keep the scouts busy while they were waiting to operate, troop 27 of Stewartstown Pennsylvania setup the following activities: how electricity is generated; see how ac is converted to dc; what is the difference between motors and generators; morse code activities; antenna building and oscillator building activities.

There were eight K2BSA portables operating during JOTA this year. All the call areas will be used next year.

**Uruguay (CX)**

participants:	140
stations:	7
internet:	5
countries:	5

The scout group "Padre José Molas" wrote that the furthest contact during the JOTA was with CP7LS in Bolivia where they spoke with a scout Santiago.

**World Scout Bureau (HB9S)**

participants:	5
stations:	1
internet:	1
countries:	67

The Amateur Radio station of the World Scout Bureau HB9S was operated by station manager Yves Margot HB9AOF, Richard Midelkoop PA3BAR and a guest crew from Luxemburg with Michel LX1KQ, Frank LX1MG and Philippe LX2AJ.

The station made 377 contacts to other scout stations during the entire weekend. Most contacts were made with Germany (29) and the USA (29), closely followed by Brasil (25) and Italy (23).

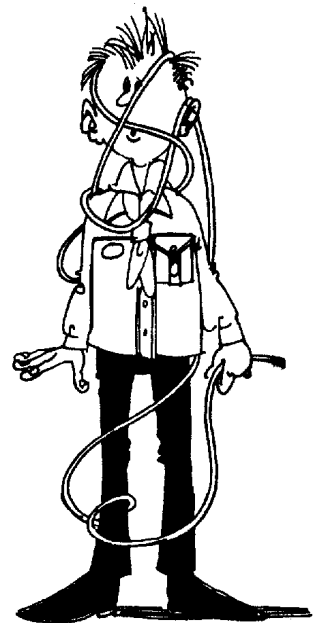

A record number of 67 different countries was contacted, as is obvious from the graph displayed here. The past few years show an increase in the number of countries we were able to contact. Are the radio conditions improving with the advent of the new solar maximum?

We noted a remarkable increase in JOTA stations in North-Africa. Scouts from Marocco, Algeria and Egypt enthusiastically contacted Geneva and told us about their activities. Sometimes with radio call signs specially obtained from the authorities, like CN42SM in Tanger, Marocco and 7X2JOTA in Algiers, Algeria.

We spoke to the explorer post in Tananarive, the capital city of Madagascar, on the air for the first time with 5R8FB. And to our long-time scout radio friends at 6V1S in Dakar, Senegal.

Of course we exchanged greetings and had an interesting chat with Dave operating GB2GP at Gilwell Park. Dave told us he turned up at the wrong time at some scout net and that's how he got the job of JOTA operator. "Not bad at all", he said, "I get three free meals a day...".

This contact was followed by a call from the headquarter station YB0S of Gerakan Pramuka in Jakarta. Tasmania in Australia hosted a national camp and rejoiced over the contact we were able to make with their station VK7XR.

And we had our share of JAM stations: A47JAM Oman, for whom we needed 10 minutes to get through the pile up of stations calling them, ED5JAM Spain, HB9JAM Switzerland, LA1JAM Norway, OH0JAM Finland, operated by Bosse from a small hut without electricity and just a small dipole antenna, PA6JAM Netherlands, where scouts were looking at a map to find Bali, only to discover it was not on the map of Europe they used....., and 9H3JAM Malta.

Ole LA2RR operated in Norway with his scouts from a tent at -7 C. Yves was happy to meet up with Nils at SKOJS with whom he had worked on the amateur satellite station at LC1J at the World Scout Jamboree in Norway in 1975. Whilst HB9KOM in Switzerland had set up on a mountain top and had to run 200 m of telephone cable (for internet) and electricity cable to the nearest farm house. We also spoke with the oldest scout group in Surinam, on the air with PZ1AP in Paramaribo. PA6JAM in the Netherlands transmitted their official opening with an interview of the first scout group (from Deurne) that has registered for the dutch National Jamboree in 2000. Former dutch JOTA Organizer Pieter Kramer

operated for the first time in 25 years a JOTA station with his own scout group at PA3BIV/J; in fact, his call sign stood model for the Bureau of Investigations and Valuables of the John Bont JOTA game. And finally Wim at PA0MER/J said that he couldn't give a signal report because he ran a demonstration for scouts with a museum military radio that had no signal meter....

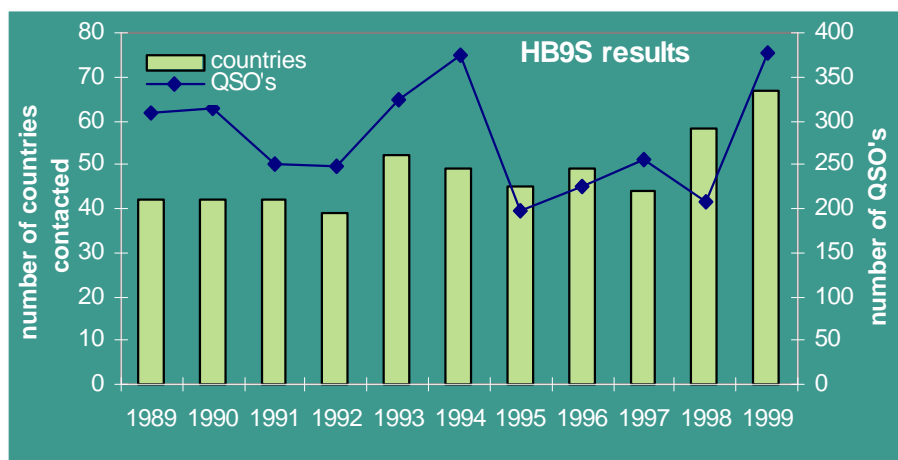

## HB9S scouts

WORLD SCOUT BUREAU GENEVA SWITZERLAND

42. World Scout  
JAMBOREE  
ON THE AIR

To radio :

**16-17 October 1999**

UTC	
MHz	
RST	

Operators :

HB9AOF Yves

PA3BAR Richard

LX1KQ Michel

LX1MG Frank

LX2AJ Philippe

73' & good scouting  
PSE QSL via bureau



# 8. Kit Corner

Following the enthusiasm of many readers, we present here the sixth edition of our electronic kit building corner. Soldering and constructing simple electronic circuits has been a popular activity during the JOTA weekend for many years. The intention of this chapter is to provide you with some ideas and suggestions.

We organised a design competition this year for electronic kits that can be built by scouts. Contrary to our expectations we received but one entry for this competition. This entry was from the UK, sent by Elizabeth Gaskell. The jury, however, concluded that it didn't fulfill all the requirements of the competition and thus no prizes were awarded. Her entry was a series of printed circuit boards with LED's in the form of star constellations, intended as a help to identify these constellations at night. Well done.

Outside of the competition, we received other kit suggestions, like a flashing ring of leds (New Zealand), an SSTV interface (UK Scout Radio Newsletter) and an electronic compass (South-Africa). We were unable to obtain a proper description of these, before the printing of this report. Maybe we will include them in the JOTA circulars later this year.

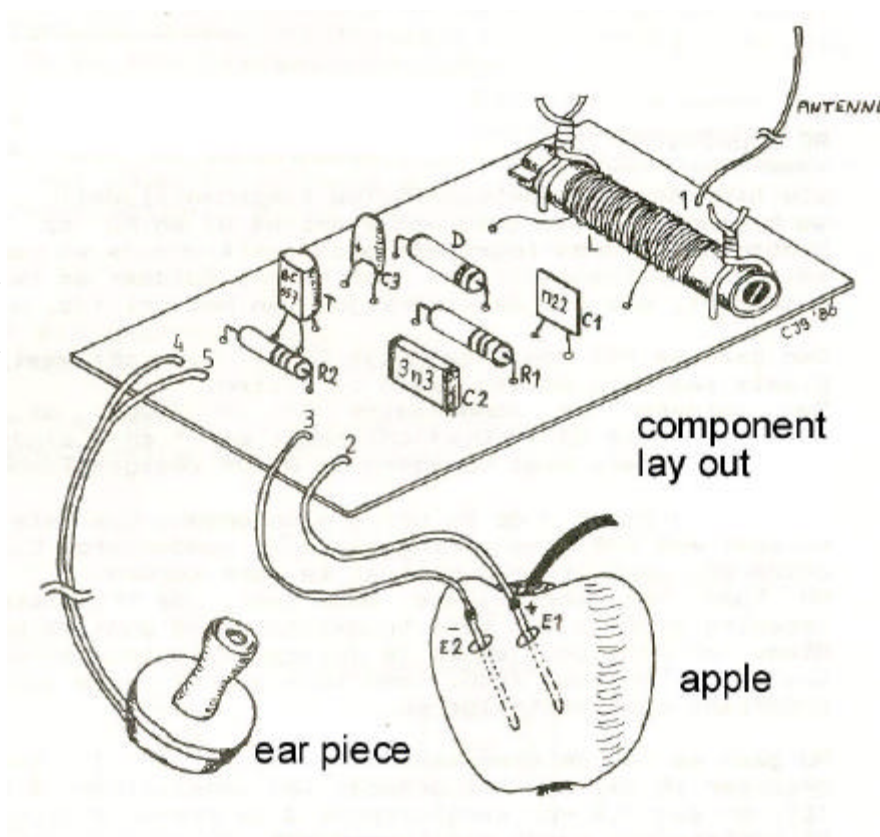

So we searched our files and we can now present you a famous design of the dutch radio scouting committee, called the *apple radio*. It is an AM broadcast receiver, powered not by a battery, but by a (sour) apple. Other sour fruits will work as well.

From the circuit diagram on this page you can see that it uses a diode to detect the AM signal of the broadcast transmitter and a one-stage amplifier with a transistor. The amplifier is powered by the apple: the copper electrode has a positive voltage with respect to the zinc electrode.

**WARNING:** you are not supposed to eat the fruits afterwards!!

Components:

R1, 2 39 kohm

C1 220 pF

C2 3.3 nF

C3 0.47 uF / 6V

L coil with 7 mm core

4 meter copper wire, lacquer-insulated of 0.2 mm diameter

D diode AA119

T transistor BC557, BC559, BC117 or similar

O earpiece of 200 ohm (not a crystal one)

E1 copper electrode 5 cm long

E2 zinc electrode 5 cm long

2 x wires for the electrodes

1 x wire of 3 meters as antenna

1 x sour apple

The copper side of the printed circuit board is also shown here. By photocopying it from this report, your radio amateur can make one for you.

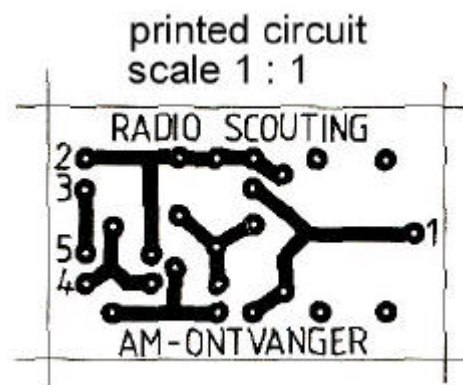

The electrodes should be put into the apple about 1 cm apart and in such a way that they do not touch each other. In case no apple or similar is at hand, a battery of 1.5 V can also be used. With this receiver, you will be able to pick up the stronger AM broadcast stations. To test it, ask your amateur radio operator to transmit an AM signal. Tuning the receiver to a different station is done by turning the core in the coil with a small

screwdriver. In case the sound is weak, a longer antenna, preferably hung outside, will help.

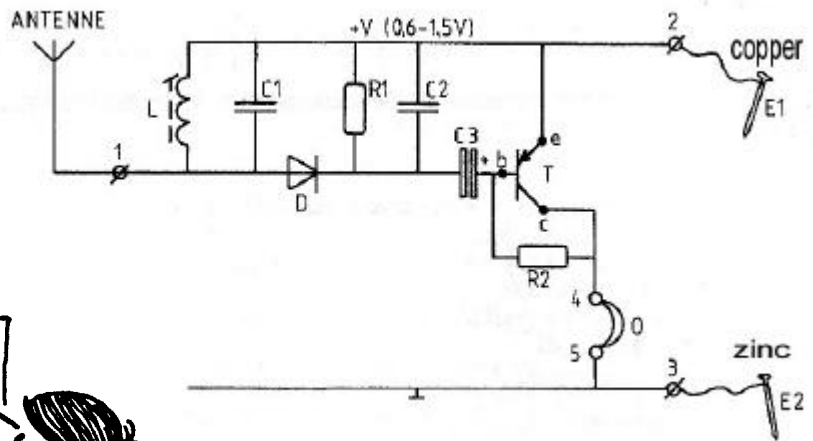
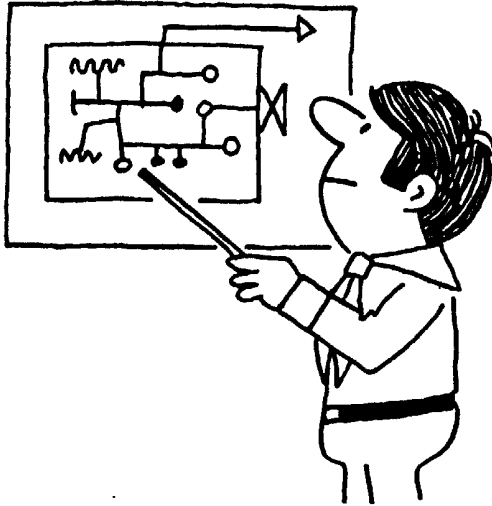

And, of course, a good and clear instruction for the scouts is needed....!





# 9. Forthcoming events

During the summer there will again be a number of large (inter)national camps and activities that have a scout amateur radio station on the air. To easily find these stations, scout stations in the European Region are asked to call CQ SCOUT daily during July and August for the universal "summer camp sked":

European Summer Camp sked:  
on 7.090 MHz at 07.00 GMT and  
on 14.290 MHz at 07.30 GMT

At the time of print, the following activities were known:

- 11 –14 May IIO5 5<sup>th</sup> European Radio Scouting Seminar, Rome, Italy. 60 participants.
- 22 – 29 July K6BSA High Sierra International, Mountain rendezvous camp, San Jose, California, USA.
- August JA1YSS 5<sup>th</sup> Nippon Venture, Kyushu island, Japan. 7000 participants.
- 9 – 19 August 5Z4KSA 4<sup>th</sup> African Jamboree, Nairobi, Kenya. 5000 participants.
- 8 – 13 Jan 2001 PS5J Pan-American Scout Jamboree, Parana, Brazil.

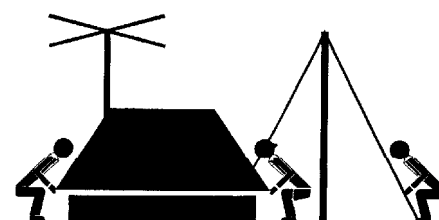

## SCOUT NETS.

Weekly or monthly nets exist in which licensed scouts exchange information on JOTA or radio-scouting in general:

Country	day	time	frequency	netcontrol
Australia	1st,3rd,5th Sunday	02.00 GMT	14.290 MHz	VK6SAN
	2nd Sunday	02.00 GMT	21.190 MHz	"
	4th Sunday of month	02.00 GMT	28.590 MHz	"
Denmark	Saturday	13.00 GMT	3.740 MHz	
European Scout Net	Saturday	09.30 GMT	14.290 MHz	PA3BAR
Germany	1st Sunday of month	16.00 GMT	3.678 MHz	DF0VCP
	3rd Wednesday of month	20.00 local	packet-convers	DB0EAM
Japan	3rd Saturday of month	23.00 local	21.360 MHz	JA1YSS
United Kingdom	Saturday	09.00 local	3.740 MHz	G4PSG
Netherlands	Saturday	19.00 local	3.740 MHz	PI4RIS
Norway	Saturday	15.30 local	3.740 MHz	
Sweden	Saturday,even weeks	15.00 local	3.740 MHz	
United States	Sunday	20.30 GMT	14.290 MHz	K2BSA

Since many years, scout stations have used the frequencies below to easily find each other on the bands.

## 5th European Radio Scouting Seminar.

From 11 till 14 May 2000, the 5th radio-scouting seminar will take place in Rome, Italy. It will bring together nearly all National JOTA Organizers in Europe, including guests from other regions (a.o. the NJO of New Zealand will take part). This time the scope of the seminar will be wider than just radio, It will concentrate on communication means available to scouts and how these can best be used in the scout programme. Notably the use of digital communications as packet-radio networks and internet will be discussed.

The seminar is aimed at those leaders responsible at a national level for radio-scouting, internet and communication. Participants from WAGGGS Associations are kindly invited to this seminar too. During this weekend a special station IIO5 will operate from the seminar venue.

## World Scout Frequencies:

band	phone (MHz)	cw (MHz)
80 m	3.740 & 3.940	3.590
40 m	7.090	7.030
20 m	14.290	14.070
17 m	18.140	18.080
15 m	21.360	21.140
12 m	24.960	24.910
10 m	28.390	28.190

# 10. The 43rd JOTA

## 43rd Jamboree-On-The-Air, 21 - 22 October 2000.

The logo for the first JOTA in the new millennium, the 43rd JOTA, is shown on this page. It is a design following an idea from the Raposa patrulla, AEP gruppo 23 in Quelul, Portugal.

Now is the moment to start your preparations !! The first JOTA of the new millennium challenges your imagination. How about giving the year 2000 a special place in your JOTA weekend programme? The World Scout Bureau's amateur radio station already obtained a special call sign for this special JOTA: we will use **HB 2 S**.

### *Look for this information:*

The following information will be mailed on paper to all Scout Associations as well as emailed directly to those National JOTA Organizers listed in chapter 11. The email versions contain the documents in PDF format.

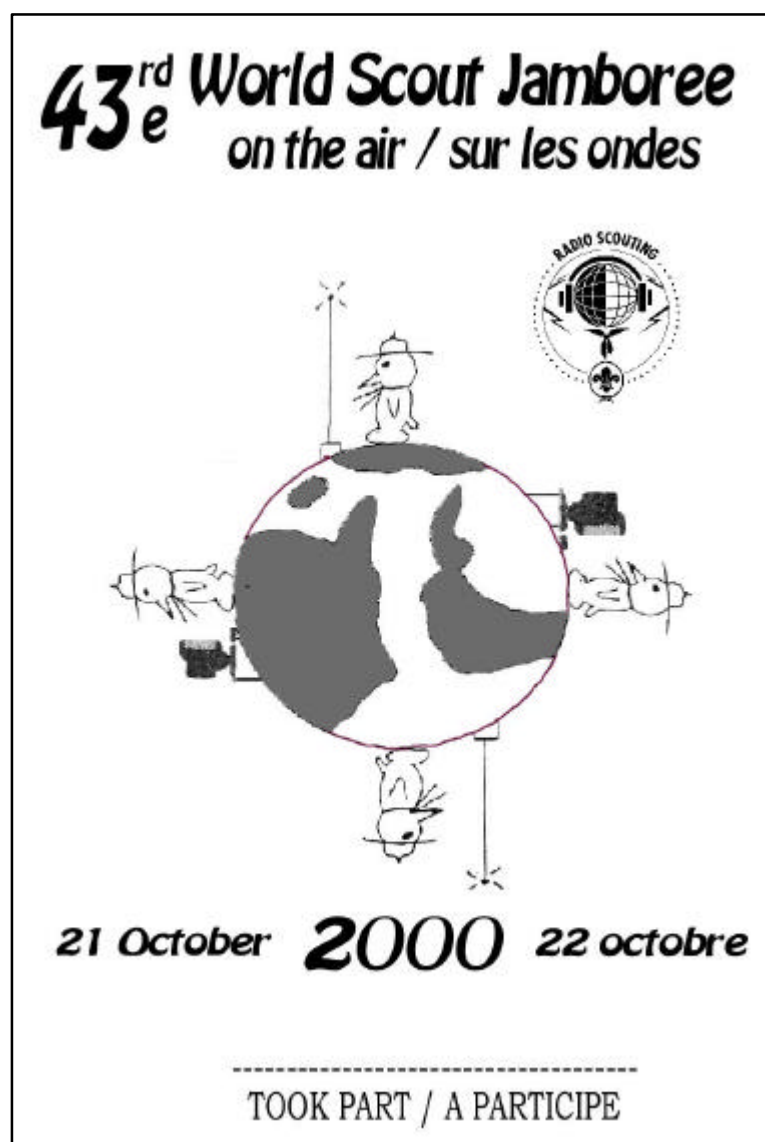

June 2000:

the first JOTA circular, with proposed theme activities and programme suggestions for the 43rd JOTA that you may use in preparing your national JOTA programme.

August 2000:

the second JOTA circular with the latest JOTA news, the operating frequencies and a report form for national use. With this mailing the participation cards will also be sent.

November 2000:

the third JOTA circular with a reminder to send your reports on time to Geneva and some last minute informations on Radio-Scouting activities.

March 2001:

the World JOTA Report (WSB ref.nr 1310) will be there again. Extra copies can always be ordered directly from the World Scout Bureau for the price of Sfr. 8.- (US\$ 5.70) surface mail for Europe and Sfr. 10.- (US\$ 7.-) airmail elsewhere. You can also order your copy on-line at the web site of SCORE, the world scout shop: [www.worldscoutshop.org](http://www.worldscoutshop.org). Look in the radio-scouting section.

The World Scout Bureau also has the following

leaflets available (consult your Scout Association for ordering instructions):

- JOTA, how to take part in this annual activity; WSB ref. number 1311 (English, French, Spanish or Russian).

You may also check the WOSM web site for JOTA information at regular times: <http://www.scout.org>.

In addition, the circulars are also uploaded to the "scouts@WW" and "jota@WW" sections of packet-radio bulletin boards at regular times. Check your own packet-radio mailbox server station.

# 11. JOTA Organizers

- World Organization** : World Scout Bureau, P.O.Box 241, CH-1211 Geneva 4, Switzerland;  
email: JOTA@world.scout.org.
- HB9S station manager and JOTA advisor** : Mr. Yves Margot, 7 Rte.A. Ferrand, CH-1233 Lully, Switzerland;  
packet: HB9AOF@HB9IAP.SROM.CHE.EU email: hb9aof@uska.ch.
- World JOTA organizer** : Mr. Richard Middelkoop, Aak 8, NL-9801 MD Zuidhorn, The Netherlands;  
packet: PA3BAR@PI8AWT.#GRO.NLD.EU email: PA3BAR@Amsat.org.

*This list contains the names of the active National JOTA Organizers (NJO), i.e. those who have sent reports to the World Scout Bureau at least once during the past two years. Packet-radio- and email addresses have been added where known to us. Information on JOTA is sent directly to the NJO's below and is also sent automatically to the International Commissioner of every Scout Association as well as to the World and Regional Scout Committees.*

- Australia** : Mr. Harvey Lennon, VK7KSM@VK7GL, P.O. Box 97, South Hobart TAS 7004.  
Email: harvey\_lee@primus.com.au.
- Austria** : Mr. Walter Nowakowski, OE1WN, Breitegasse 13, A-1070 Wien.  
Email: BBPAF@ppoe.at.
- Bolivia** : Mr. Camilo Zeballos Gutierrez, Casilla postal 3093, Cochabamba.  
Email: scoutasb@comteco.entelnet.bo.
- Canada** : (SC) Ms. Lena W. Wong, Scouts Canada, P. O. Box 5151 Station  
LCD-Merivale, Ottawa, Ontario K2C 3G7. Email: lwong@scouts.ca.  
(ASC) Mr. Jean-Yves Ruault, VE2JAM, 7679 avenue Papineau,  
Montreal, Quebec, H2E 2H1. Email: jslo@asc.ca.
- Chile** : Mrs. Isabel Carreño Arellano, CE3TLE, Casilla 21113, Santiago 21.  
Email: CE3TLE@hotmail.com.
- China Republic** : Mr. Tim Kuo, 13F, 20 Chu-Lun Street, Taipei 104.  
Email: timk@scout.org.tw.
- Croatia** : Mr. Vladimir Jurkic, 9A1ACD, Pino Budicin 31,HR-52100 Pula.  
Email: tjurkic@hotmail.com.
- Cyprus** : Mr. Errikos Lanitis, 5B4GJ, P.O.Box 40216, Larnaca 6302.
- Czech Rep.** : Ms. Hana Koncicka, OK1TMP@OK0PPR, Malenicka 1791, CZ-  
14000 Praha 4.  
Email: hkvs@volny.cz.
- Denmark** : Mr. Brian Lodahl, OZ2BRN, Sonjavej 42, 1A, DK-9000 Aalborg.  
Email: brianlodahl@kfumscout.dk.
- Dominica** : Mr. Joseph Russell Raymond, J73RJ, P.O. Box 677, Roseau.
- Finland** : Mr. Markus Hamro Drotz, OH2KMT, Siirinkuja 2, FIN-02700  
Grankulla.Email:oh2kmt@sral.fi
- France** : Mr. Luigi Malandrino, F6ICJ@F1DRW, Chemin du clos devant, F-71960 Prissé.  
Email: lmalandr@scouts-france.fr.
- Germany** : (DPSG) Mr. Klaus D. Sperling,DC4NA@DB0BOX, Leharstrasse 8b, D-90453 Nürnberg 60.  
(VCP) Mr. Günter Erdmann, DL9BCP@DB0VER, Wecholderstrasse 59, D-28277 Bremen.  
Email: gerdmann@gmx.de.  
(BdP) Mr Lars Weimar, DG4SEV@DB0ULM-8, Schammmental 3, D-89134 Blaustein.  
Email: lars.weimar@bluewin.de
- Guatemala** : Mr. Dafnes Rossatty, TG9ARD, 3a Calle "B" 15 - 40, zona 1. Guatemala 01001.  
Email: drossatty@c.net.gt.
- Honduras** : Mr. Raul H. Delcid Castro, HR1RHD, Col Ruben Dario Frente Gimnasio Cibex,  
258 Tegicigalpa M.D.C.. Email: scouts@ficensa.com.
- Hong Kong** : Scout Amateur Radio Club, 10/F Hong Kong Scout Centre, 8 Austin Road, Kowloon.  
Email: vr2ea@scout.org.hk.
- Hungary** : Mr. Tibor Végh, HA5YI@HA5OB, Kerepesi-u 30 I 21, H-1148 Budapest.





- Email: ha5yi@gw.ha5kfu.ampr.org
- Iceland** : Mr. Konrad Thorisson, TF3KET@TF3NOS, Godatun 5, 210 Gardabaer. Email: konth@skima.is
- India** : Mr. S.Kumar, VU2BSG, 16 Mahatma Ghandi Marg, Indraprastha Estate, New Delhi 110002.
- Indonesia** : Mr. H. A. Rivai Harahap, Jl. Medan Merdeka Timur No. 6, Jakarta 10110.  
Email : kwarnas@jakarta.wasantara.net.id
- Ireland** : Pat Geoghegan, EI9EZ@EI2HH, 24 Shanbally, Cappoquin, Co Waterford.
- Japan** : Mr. Toichiro Nishiyama, JA1OBY@JR1ZQI, No.11-10, 4-chome, Osawa, Mitaka-shi, Tokyo 181-0015.
- Kuwait** : Mr. Mohamed H. Al-Humaidi, P.O. Box 5172 Safat, 13052 Kuwait.  
Email: scout@mail.qualitynet.net.
- Madagascar** : Mr. Ranarisaona Raymond, P.O. Box 4402 Salfa Tananarive, 101 Antananarivo.  
Email: appio@salfa.org
- Malaysia** : Mr. Wang Nyap Tang, 6 Lorong Bunga Kekwa, Taman Bunga Kekwa, 14000 Bukit Mertajam, Penang. Email: wntang@tm.net.my.
- Morocco** : Mr. Adil Freidji, 57 bloc 3 youssoufia est, Rabat 10000.
- Mozambique** : Mr. Silvio José Monteiro, Rua Costa Serrao 231 e/c, Beira. Email: ferreira.lda@telepata.mz
- Neth. Antilles** : Mr. Hubert Martha, PJ2SA, Kaya Araña 93, Romar Estate, Curaçao.  
Email: Hubertmartha@hotmail.com.
- Netherlands** : Mr. Jan Kluiver, PB0AMJ, Lallamanstraat 18, NL-2841 CD Moordrecht.  
Email: PB0AMJ@Amsat.org.
- New Zealand** : Mr. Jim Parnell, ZL2APE@ZL2WA, 87 Duncan Terrace, Kilbirnie, Wellington 6003.  
Email: jim-p@ihug.co.nz.
- Norway** : Mr. Dag Anders Kjærnes, Ravnaasveien 87, N-1254 Oslo. Email: dagak@online.no.
- Oman** : Mr. Dawood Nadhar Al-Zadjali, A41JX, National Organisation for Scouts and Guides, P.O.Box 1528, PC 112 Ruwi. Email: omnscout@gto.net.om.
- Panama** : Mr. Eric A. Macias, HP1EAM, Bethania Calle 67 final, 6-8783 El Dorado Panama.
- Papua N Guinea** : Mr. Barry Bailey, P.O. Box 44, Konedobu, NCD.
- Poland** : Mr. Jan Ladno, SP5XM, ul. Nowolipki 10 m 80, PL-00-153 Warszawa.
- Portugal** : (CNE) Mr. José Augusto Marques Joaquim, CT1EHZ, Rua Dom Tristao Vaz Teixeira no. 5 - 2º, Frente, P-2675 Odivelas.  
(AEP) Mr. Manuel Celestino dos Santos Martins, CT1ASU@CS0RCL, Rua Manuel Martins Garrocho 7 1º, P-8700-497 Olhão. Email: radioescotismo@mail.pt.
- Romania** : Mr. Nicolae Draguleanu, YO3CZ, Dem. I. Dobrescu no 4 - 6, sector 1, Bucuresti.  
Email: ndraguleanu@pcnet.pcnet.ro.
- Senegal** : Mr. Mamadou Daffe, 6W1IRQ, 5 Rue Pierre Millon, BP744, Dakar. Email: cod@telecomplus.sn.
- Slovakia** : Mr. Josef Bojanovsky, OM3OF, Kosikarska 14 / 1431, 915 01 Nove Mesto nad Vahom.
- Slovenia** : Mr. Primož Bajec, S57RUT, Pivska 1, SI-6230 Postojna. Email: bajecp@hotmail.com.
- Spain** : Scouts de Aragón ASDE, Fernando de Antequera 2, E-50006 Zaragoza.  
Grupo Scout Severo Montalvo ASDE, P.O. Box 148, E-30880 Aguilas. Email: ciadj@ceta.es.
- South-Africa** : Mr. Dave Gemmell, ZS6AAW, P.O. Box 77, Irene 0062. Email: Ber@Mweb.co.za.
- Sri Lanka** : Mr. K.H. Camillius Fernando, 4S7CF, 65/9 Sir C. A. Gardiner Mawatha, Colombo 2.  
Email: slscouts@sri.lanka.net.
- Sweden** : Mr. Jan Eliasson, SM7NDX@SM7FEJ, Klevavagen 3 C, SE-56027 Tenhult.  
Email: sm7ndx@mail.scout.se.
- Switzerland** : Mr. Jürg Herbeisen, HB9JAM, Greyerztstrasse 97, CH-3013 Bern.  
Email: juerg.hebeisen@switzerland.org.
- Tanzania** : Mr. Osmund Y. Kipengere, P. O. Box 945, Dar Es Salaam.
- Thailand** : Ms. Sasithara Pichaichannarong, E20BHV@HS0AC, National stadium, Rama Road, Bangkok 10250. Email: sitra@mozart.inet.co.th.
- Turkey** : Mr. U. Savas Baran, Simsek S. 36/13, Kavaklidere, TU-06540 Ankara.  
Email: bsavas@marketweb.net.tr.
- United States** : Mr. Ray Moyer, WD8JKV, 1325 West Wallnut-Hill Lane, Irving, Texas 75015-2079.  
Email: rayjkv@aol.com.